

VOICE and/or DATA CELLULAR SYSTEM

The **Voice/Data** or **Data Only** Cellular System operates on DoorKing's cellular network that is hosted on the AT&T 4G LTE network where available. The system provides voice communication, data communication, or both, depending on the registration plan selected on DoorKing's Cellular Server website.

The **VOICE/DATA** or **DATA ONLY Cellular System** is designed to be used with:
- **1833, 1834, 1835, 1837, and 1838** entry systems.

The **Voice/Data** cellular system **MUST** be wired to the telephone entry system's **phone line** (voice) and **RS 232 connection** (data). See page 2.

The **Data Only** cellular system is only wired to the telephone entry system's **RS 232 connection** (data). See page 2.

The **Voice/Data** or **Data Only** cellular system will work with **TWO** 1830 entry systems connected to it. These are designated as **System A** and **System B**. See next page to wire 2 1830 entry systems to the cellular system.

Prior to Installation:

An existing cellular phone will be needed to test the signal strength of DoorKing's cellular network in the desired installation location (a smart phone is preferred).

Analog modems **DO NOT** work on a cellular network.

BEFORE the cellular system can be installed, the installation location **MUST BE TESTED** for good cellular signal strength for reliable communication. **TEST** this location using an existing active cellular phone with **ANY** of these cellular phone services that all use the same network:

- AT&T
- Consumer Cellular
- Cricket Wireless
- Go Phone
- Straight Talk

Note: Other cellular phone services use different networks and will not work for testing signal strength of the cellular system.



Activate the phone near the position where you want the plastic enclosure to be installed. 3-4 bars of signal strength should be indicated on the phone for a reliable signal. If 3-4 bars are not achievable in that specific location, then try moving the phone around and see if at least 3-4 bars can be achieved and maintained in a nearby location. If a smart phone is being used, try using the browser to connect to a website to verify good data transfer. **DO NOT install the enclosure in a WEAK or NO signal area.** Generally, the higher the enclosure is mounted, the better the reception. This also helps protect against vandalism. The enclosure should be located to minimize the wire runs to **"SYSTEM A"** 1830 telephone entry system. Keep the wire run between the two devices as short as possible, maximum 100 feet. This allows less chance for lightning surges or other electrical interference to disrupt the cellular signal. Keep the enclosure away from any metal. This can also disrupt the signal. After the 3-4 bar signal strength has been confirmed (and the smart phone has good browser data transfer if used for signal testing), the installation can begin.

Installation Steps:

1. Install and wire cellular system to 1830(s) (page 2).
2. Power up cellular system (page 3).
3. Register cellular system (and 1830(s)) online, this can be done before or after cellular system has been installed (page 3).
4. Test cellular system (page 3).
5. Program cellular system (pages 4&5).
6. Troubleshoot cellular system if necessary (page 5).

Note: Installation steps assume that a good cellular signal has been tested at installation location and the 1830 system(s) has already been setup and functioning including the **master code** and **multiple system programming** if 2 1830s are being used.

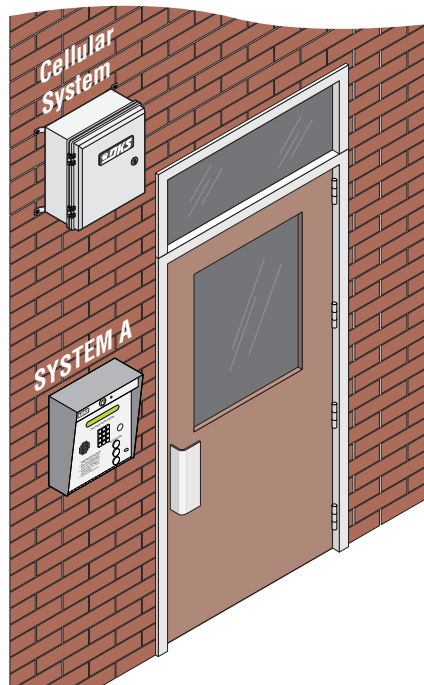

Copyright 2015 DoorKing, Inc. All rights reserved.

DKS
DOOR KING
120 S. Glasgow Avenue
Inglewood, California 90301 U.S.A.

Wiring

DKS Cellular Server
hosted by AT&T cellular network
with DKS Online Registration Completed

System A Terminal	1830 Terminal
DATA OUT	1
DATA IN	2
BUSY OUT	3
BUSY IN	4
GROUND	5

Voice/Data Cellular System

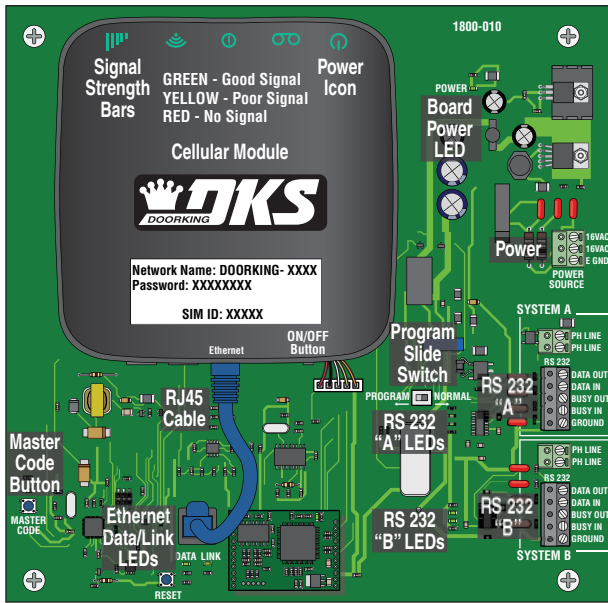

The **EARTH GROUND** must be connected to a proper ground close by (ground rod, cold water pipe in the ground, existing electrical ground, etc.).

Installation

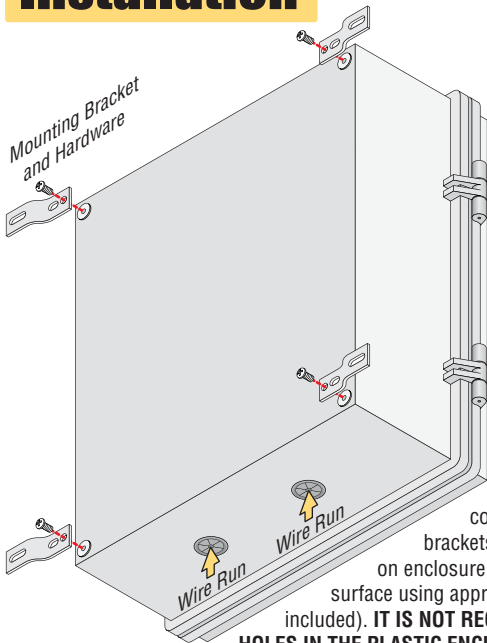

System B Terminal	1830 Terminal
DATA OUT	1
DATA IN	2
BUSY OUT	3
BUSY IN	4
GROUND	5

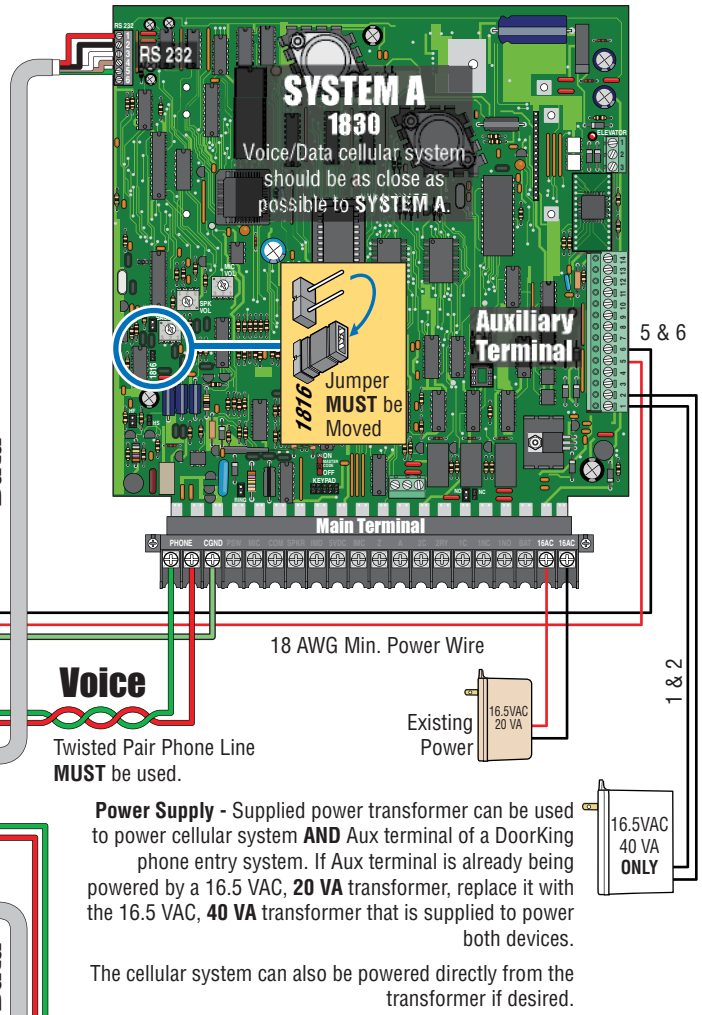
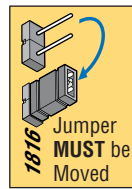

Power Supply - Supplied power transformer can be used to power cellular system **AND** Aux terminal of a DoorKing phone entry system. If Aux terminal is already being powered by a 16.5 VAC, **20 VA** transformer, replace it with the 16.5 VAC, **40 VA** transformer that is supplied to power both devices.

The cellular system can also be powered directly from the transformer if desired.

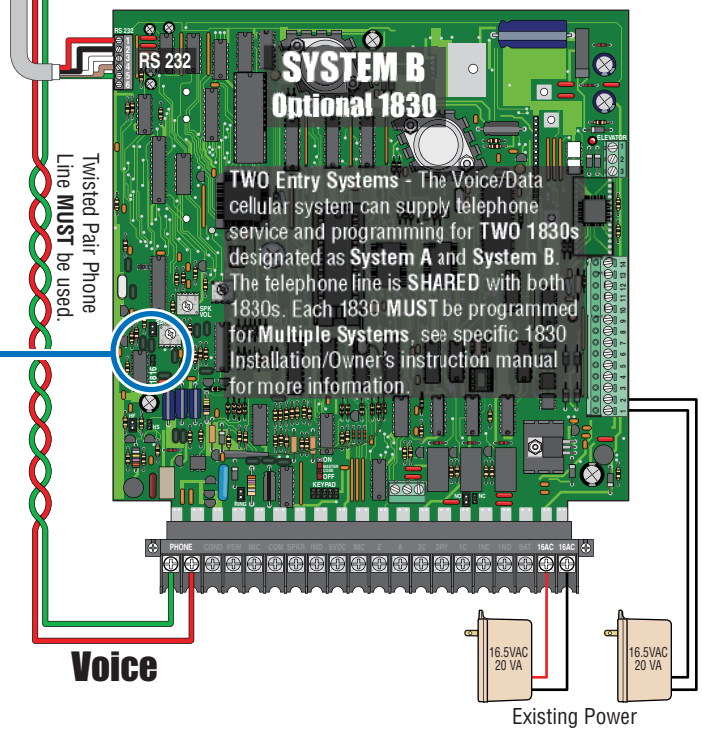

If holes must be drilled, remove the circuit board before drilling and be sure that mounting bolts/screws do not touch the back of the circuit board. Holes must be sealed to prevent water intrusion.

Voice/Data Cellular System Needed Information

Powering Up System - The Voice/Data cellular system will **NOT** function until **online registration** has been successfully completed on DoorKing's Cellular website. Within 1 minute of powering up the cellular module, the lights should turn on. If they don't, check that the ON/OFF button is turned ON. Signal strength Bars should be lit **GREEN** indicating good cell reception. **YELLOW** bars indicates poor reception but may still work. **RED** bars indicates no reception. The cellular module's lithium battery needs time to charge. Allow at least ½ hour of charging time before using system.

Using Two 1830 Entry Systems - Each 1830 must be programmed for **MULTIPLE SYSTEMS**. see specific 1830 Installation/Owner's instruction manual for information to program each 1830.

TWO 1830 Entry Systems Master Codes -Each 1830 entry system's Master Code must be **DIFFERENT**. The DKS cellular server identifies each 1830 by its unique master code. This allows separate programming for each 1830.

Voice/Data Cellular System Master Code - **IMPORTANT** Program the Voice/Data cellular system master code the **SAME** as **System A's** master code. See Programming for instructions on how to set the cellular system master code on page 4. The DKS cellular server may need to contact the Voice/Data cellular system and uses **System A's** master code to do so.

RS 232 Baud Rate for Older 1830s - The Voice/Data cellular system and the 1830 entry system(s) **MUST** have matching RS 232 baud rates (bps). Newer 1830s and the Voice/Data cellular system default to **19,200bps** but older 1830s may be running at **ONLY 9600bps**. It is preferred re-programming older 1830s to 19,200bps. If the older 1830s cannot be re-programmed up to 19,200bps, then the Voice/Data cellular system can be re-programmed down to 9600bps to match the older 1830s. Contact tech support for instructions on how to re-program the cellular system down to 9600bps.

Battery Back-Up - The cellular module contains a lithium battery which will **ONLY** power the cellular "Voice" system during a power outage for approximately two hour depending on usage. The 1830 and the cellular system's "1800-010 Circuit Board" **MUST** also have a back-up battery installed to operate during a power outage. DoorKing recommends using a DKS Model 1000 power inverter for full system backup.

Battery Replacement for the Cellular Module - The lithium battery may be completely discharged when received. Allow at least ½ hour of charging time before using the cellular system. The lithium battery is located on back of the 1800-010 circuit board. The board must be removed to gain access to the battery. The foam block **MUST** be re-installed to prevent the battery from coming loose in the battery compartment.

Online Registration MUST be Completed

DKS Cellular requires a **SEPARATE** registration from the DKS IM Server. If a customer already has an IM Server account and wants to add a DKS Cellular system, this will require a **SEPARATE** User ID and Registration.

- DKS IM Server includes: **IM Server Modem** and **IM Server Client**.
- DKS Cellular includes: **Cellular Phone** and **Data Transfer**.

Before registering a cellular system on DoorKing's Cellular Server you will need:

- **SIM ID** number located on the cellular module (number is unique for each cellular module).
- Master Code of **System A**.
- Master Code of **System B** if connected, **MUST** be a different master code than System A.

OPTION 1. Go to DKS cellular website: <https://dksdb.dksoftware.com/NewUserRegChoice.aspx> to register, follow instructions on website.

OPTION 2. Online registration is directly offered when installing the DoorKing Remote Management Software version 6.3.g or later on YOUR internet connected PC.

Create an account and select whether the account will manage:

- **Voice and Data** (entry systems 1833, 1834, 1835, 1837, or 1838 with voice)
- **Data Only** (1838 with no voice)
- **Voice Only** (limits available features that can be used on all 1830 entry systems and is not recommended for the 1830s)

Enter the **SIM ID** number to identify the **Cellular System** to the account created. After the SIM ID number is entered along with the local billing address, **a local cellular phone number will be assigned** to that cellular device.

Register the 1830 systems (Master Codes) to the account. The **FIRST 1830 master code** entered will be identified as **System A**. If a second 1830 master code is entered, it will be identified as **System B**.

Testing

Final Testing after the Cellular System has been Registered - All systems should be tested and final adjustments done. Connect a telephone butt set to the cellular system circuit board **Phone Line** and make sure the line is active and that phone calls may be made and received.

If the phone line is not active, something went wrong during the registration which must be corrected. If still having problems, call DoorKing tech support. Attach a label to the inside of the cellular enclosure listing the local phone number that was assigned during registration. For **DATA ONLY** cellular systems skip the voice testing and proceed to remote program testing.

Voice Testing - On the 1830 circuit board lower left corner is a jumper for phone line matching. Remove the jumper from the **UPPER position** and place it on the **LOWER position** labeled **1816**. This allows the 1830 speakerphone optimum performance when using cellular.

Program a phone number into the memory of the 1830 using the 1830 keypad. Then call that programmed number on the 1830. Have the call recipient press "9" on their phone to open the door. Verify the 9 tone is detected (door will open). Adjust the feedback on 1830 as necessary. See specific 1830 Installation/Owner's instruction manual for programming and adjustment information.

Note: Factory set **Tone Open** numbers: 9 tone activates Relay 1. 0 tone activates Relay 0. 5 tone activates Relay 2. For cellular, the preferred tone for Relay 2 is the 8 tone.

Remote Program Testing - Install DoorKing Remote Management Software version 6.3.g or later on an internet connected PC that will be used for 1830 programming and management. Create an account and open the system Info screen. Enter **System A's** master code, **phone number that has been assigned**, and pick **DKS Cellular** for the service type. If a second 1830 is connected, create a second account with the same settings as above except System B's master code **MUST** be different. Refer to the Remote account manager software manual for additional settings which **MUST** be made. Enter some test data into the resident screen and then attempt to send the data to the 1830.

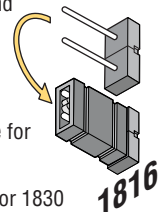
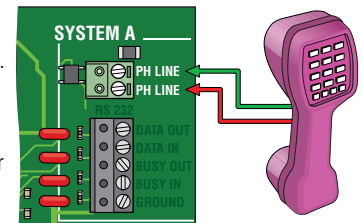

Programming

The Voice/Data Cellular System can be programmed for certain maintenance features. Normally these do not need to be set or adjusted. This programming can be done locally at the cellular system itself **using a touch tone butt set** as a programming tool or remotely by calling the cellular system using a touch tone telephone.

Program Slide Switch - Slide this switch to program when programming the board **LOCALLY** using a touch tone telephone. Be sure to switch back to Normal when finished programming. Cellular voice will **NOT** work with program slide switch set to program.

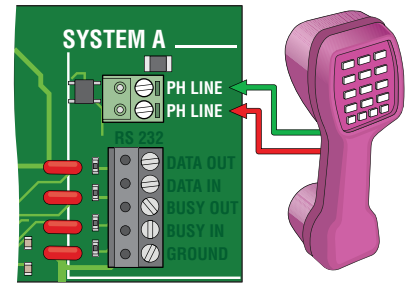
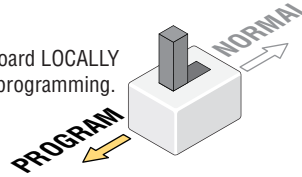

Setting the Master Code for Voice/Data Cellular System:

Slide switch to Program

Connect a touch tone phone to **System A** phone terminals. Press and release the Master Code push button. Enter on the phone the new 4 digit Master Code and then press *. A tone should be heard in the phone ear piece. The new master code is now programmed. Hang up the phone to end programming. Note: The cellular system's master code **MUST** be the **SAME** as **System A** 1830 master code. This is how the DKS cellular server identifies the cellular system to contact it if needed. Set the slide switch back to Normal if done, or leave in Program if more programming will be done.



Cycle Power to the Cellular Module:

This will cycle power to the cellular module if power is ON or it will turn ON the module if it is OFF. This allows the module to re-connect with the cellular network. Slide Switch to Program:

87 Master Code(Beep) 01(Beep) 1*(Beep) to **cycle power** or 0*(Beep) to **NOT cycle power**.

Hang up Phone Slide switch back to Normal if done programming.

TCP/RS 232 Factory Defaults

This will RESET the TCP/RS 232 module back to factory defaults.

Slide switch to Program:

87 Master Code(Beep) 02(Beep) 1*(Beep) to **reset defaults** or 0*(Beep) to **NOT reset defaults**.

Hang up phone. Slide switch back to Normal if done programming.

Cycle Power to Cellular Module Schedule:

This schedules the number of days between automatic power cycling of the cellular module. This allows the module to re-connect with the cellular network after periods of non-usage. The revision letter of YOUR specific circuit board will restrict programming to either "number of days-Rev A ONLY" OR "number of hours-Rev B or higher".

"Rev A" Circuit Board ONLY, "0-9" number of days:

Note: 0= no cycle. 1= every day, 2= every two days, 3= every three days etc. Up to every 9 days.

Factory default setting: every 3 days.

Slide switch to Program

87 Master Code(Beep) 03(Beep) 0-9*(Beep) **number of days** to cycle power.

Hang up phone. Slide switch back to Normal if done programming.

"Rev B or higher" Circuit Boards, "00-99" number of hours:

Note: 00= no cycle. 01= every hour, 02= every two hours, 03= every three hours etc. Up to every 99 hours.

Factory default setting: every 3 hours.

Slide switch to Program

87 Master Code(Beep) 03(Beep) 00-99*(Beep) **number of hours** to cycle power.

Hang up phone. Slide switch back to Normal if done programming.

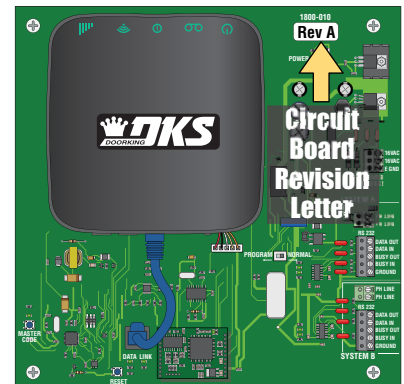

Number of Rings to Answer Call:

Sets the number of rings for an incoming call before the cellular system will answer. 2= two rings, 3= three rings, etc. Up to 9 rings. (2-9)

Normally the 1830 will answer on the second ring. In this case the cellular system will listen in for DTMF tones *87 Master code. If received, the cellular system will stay on the line for programming while the 1830 will hang up. If any other DTMF tones are received, the cellular system will ignore them. If the 1830 does not answer on the second ring, the cellular system will answer on the programmed number of rings.

Factory default setting: 5 rings.

Slide switch to Program

87 Master Code(Beep) 04(Beep) 2-9*(Beep) **number of rings** before answering call.

Hang up Phone. Slide switch back to Normal if done programming.

TCP/RS 232 Power Cycle:

Sometimes it is necessary to cycle power to the TCP/RS 232 module to re-establish an Ethernet connection to the cellular module.

Slide switch to Program

87 Master Code(Beep) 05(Beep) 1*(Beep) to **cycle power** to TCP/RS 232 module or 0*(Beep) to **not cycle power**.

Hang up phone. Slide switch back to Normal if done programming.

Multiple Program Note: Once the *87 Master Code(Beep) has been keyed in and programming mode is entered, It is possible to program **multiple** functions without leaving the programming mode. Just complete one program step and then go to the next.

Programming Example: Master Code is 1234. Cycle power to the cellular module and then cycle power to the TCP/RS 232 module.

*87	1234	(Beep)	01	(Beep)	1	(Beep)	05	(Beep)	1	(Beep)	Hangup
	enter		cycle		cycle		exit				
	programming		module		TCP/RS 232		programming				
	mode		power		power		mode				

The cellular system will remember the commands received and execute them in order when program mode is exited.

Remotely Programming

DoorKing Part Number
1800-080

Note: DTMF tones don't work well over the cellular network. It is NOT recommended REMOTELY programming when using DTMF tones.

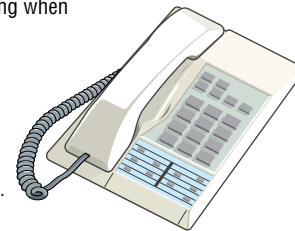

The Voice/Data Cellular System can also be programmed remotely from a touch tone telephone. It is best to use a telephone with a desktop keypad and not a keypad in the handset so that the Beeps can be heard.

Call the telephone number of the cellular system. After a couple of rings the system will answer and respond with an answer tone. Programming may now proceed on previous page. To end programming press # and then hang up.

Troubleshooting

Voice Not working:

Are the lights on the cellular module ON? If not, look for circuit board power LED. If ON, program the board to **cycle power ON** to the cellular module. See "**Cycle Power to the Cellular Module**" programming on page 4.

Program/Normal slide switch left in PROGRAM position. Slide back to NORMAL position.

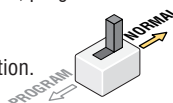

Poor cellular reception. Look for cellular module "Signal Strength Bars" to be GREEN. If bars are YELLOW or RED, poor or no reception is occurring.

Registration is not complete OR DATA ONLY has been selected. Service suspended because of past due bill. Contact DoorKing for support.

Data Transfer Not Working:

Are the lights on the cellular module ON? Is the board power LED ON? If yes, program the board to **cycle power** to the cellular module. See "**Cycle Power to the Cellular Module**" programming on page 4.

Poor cellular reception. Look for cellular module "Signal Strength Bars" to be GREEN. If bars are YELLOW or RED, poor or no reception is occurring.

Registration is not complete OR VOICE ONLY has been selected. Service suspended because of past due bill. Contact DoorKing for support.

Wiring error from the cellular system to the entry system. Check RS 232 wiring.

Master code mismatch. Master code for the 1830(s), PC software, and DKS cellular website **MUST** match each other.

Check for remote account manager error messages for failure reasons such as memory size, anti passback mismatch, etc, and correct errors.

1830 wiegand/RS 232 power is missing. Check for 16.5VAC at 1830 auxiliary terminals 1,2.

Try connecting a laptop directly to the 1830 and see if possible to transfer data.

Check the LED lights on the Voice/Data cellular circuit board. During a data transfer the yellow Ethernet data LED should be flashing. The data LED near the RJ45 cable should be flashing. The RS 232 LEDs should be flashing for the proper system either A or B indicating attempted data transfer. If the wrong RS 232 LEDs are flashing, A and B systems are mixed up.

Check the 1830 baud rate setting. It should be 19200bps. See specific 1830 Installation/Owner's manual. Older 1830s only run at 9600bps (Rev L and earlier) (K and earlier 1838 boards) change the RS 232 baud rate setting on the cellular device. Call DoorKing tech support for help.

Network cable (RJ45 cable) loose or unplugged on the cellular board.

Cycle power to the TCP/RS 232 adapter. See "**TCP/RS 232 Power Cycle**" programming on page 4.

