

20RS Series 3/8" Short Press Fit Switch Sets



20RS-12
5/8" Length

- Lifetime Warranty
- Colors: White, Brown, Gray
- UL and ULC Approved
- Available in Open Loop, Closed Loop and SPDT
- 3/8" Diameter, Press To Fit
- Standard Lead Length 12" or Terminal Block
- Longer Leads, Zip Cord or Jacketed Cable on Request
- Ideal for Thin Framed Doors & Windows
- Built-in Resistors & Diodes Available on Request
- Switches or Magnets Available Separately
- Standard Gap 3/4"+
- Extra Wide Gap 1"+

The G.R.I. recessed "shortie" switch set is designed for applications where a 3/8" press to fit set is needed but space limitations will not allow for a full length set to be installed. With the 5/8" 20RS-12, or the .930" 20RS-T, the installer is able to protect openings that otherwise would have to be secured with more visible surface mount configurations. Available in regular and extra wide gaps, the 20RS series provides an easy answer to the difficult, high dollar window problems every installer encounters.



20RS-T
.930" Length

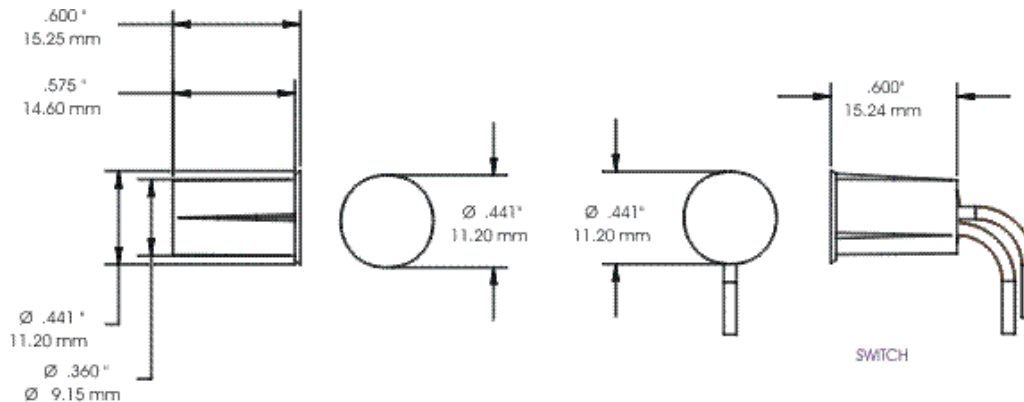

20RS-12
5/8" Length

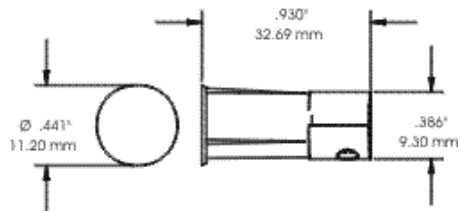
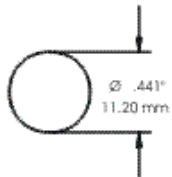
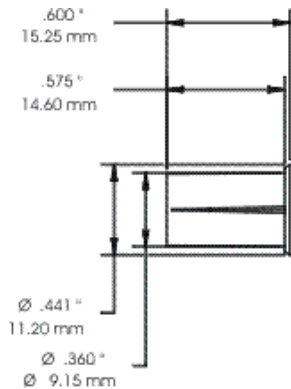

20RS-T
 .930" Length

MINIATURE 3/8" RECESSED SWITCH SET

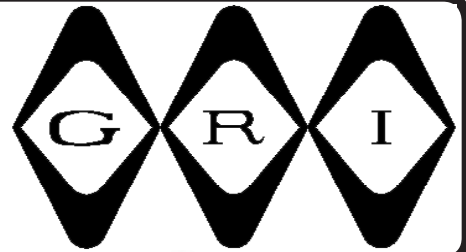

20RS-12/20RS-T SERIES



- ◆ Ideal For Thin Framed Doors and Windows
- ◆ Recessed Magnetic Contact ◆ Press To Fit
- ◆ 12" #22AWG Leads or Screw Terminals
- ◆ Longer Leads, Zip Cord or Jacketed Cable Upon Request
- ◆ Hermetically Sealed
- ◆ Plated Contacts Resist Sticking or Freezing
- ◆ Built-in E.O.L. Resistors and Diodes Upon Request
- ◆ Supervisory Loops Available Upon Request
- ◆ Switches and Magnets Available Separately
- ◆ Colors: White, Brown, Gray
- ◆ Lifetime Warranty



PART NUMBERS:

	Closed Loop	Open Loop	SPDT
Standard Gap 1/2" +	20RS-12 20RS-T	30RS-12	40RS-12
Extra Wide Gap 1" +	20RS-12XWG 20RS-TXWG	30RS-12XWG	40RS-12XWG

INSTALLATION APPLICATIONS:

The G.R.I. recessed "shortie" switch set is designed for applications where a 3/8" press to fit set is needed, but space limitations will not allow for a full length set to be installed. Just 5/8" long, the installer is able to protect openings with the 20RS-12 that otherwise would have to be secured with more visible surface mount configurations. Available in regular and extra wide gaps, the 20RS series provides an easy answer to the difficult, high dollar window problems every installer encounters.



MADE IN U.S.A.



MINIATURE 3/8" RECESSED SWITCH SET

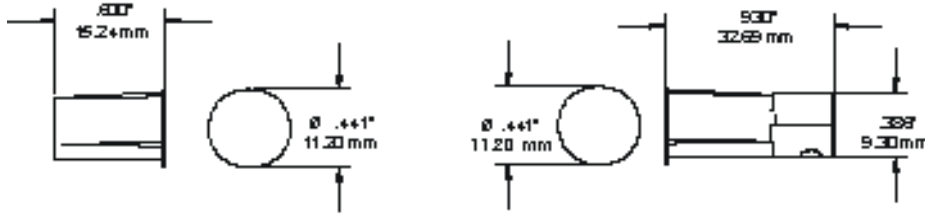

MAGNET

SWITCH

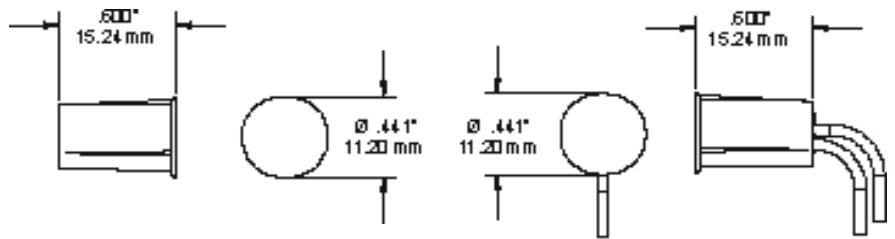

MAGNET

20RS-12

SWITCH

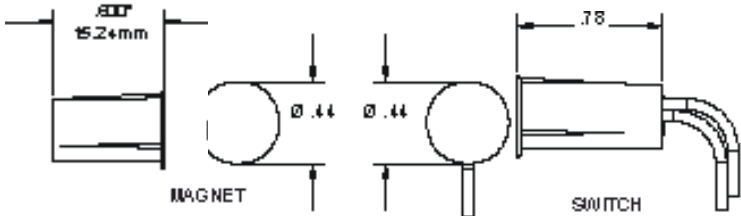

MAGNET

SWITCH

30RS-12/40RS-12

GRI products meet or exceed these minimum general specifications:

PART NUMBER	LOOP TYPE	ELECTRICAL CONFIG.	REED FORM	MAXIMUM INITIAL CONTACT RESISTANCE (Ω)	MAXIMUM CONTACT RATING (W)	MAXIMUM SWITCHING VOLTAGE (VDC)	MAXIMUM SWITCHING CURRENT (A)
20RS-12	Closed	N/O	A	.150	10	200	.500
20RS-12XWG	Closed	N/O	A	.150	10	200	.500
20RS-TClosed	N/O	A	.150	10	200	.500	
20RS-TXWG	Closed	N/O	A	.150	10	200	.500
30RS-12	OPEN	N/C	B	.140	5	175VDC	.250
30RS-12XWG	OPEN	N/C	B	.140	5	175VDC	.250
40RS-12	Open/Closed	SPDT	C	.140	5	175VDC	.250
40RS-12XWG	Open/Closed	SPDT	C	.140	5	175VDC	.250

WARRANTY: Lifetime warranty against workmanship, material and factory defects.



MADE IN U.S.A.