

## 2120 Series 3/8" Ribbed Recessed Switch Sets



**2120-12**

3/8" Press to Fit Rib Switch Set



**N2120-12**

3/8" Press to Fit Rib Switch Set

- Lifetime Warranty
- Protects Reed from Swelling Wood and Header Shift
- Covers Over-drilled Holes
- Self-centering
- Solves Angled Wire Path Problems
- Supervisory Loops Available
- Standard 12" Leads
- Longer Leads, Zip Cord and Jacketed Cable on Request
- Built-in E.O.L. Resistors and Diodes are Available
- Available in White or Brown

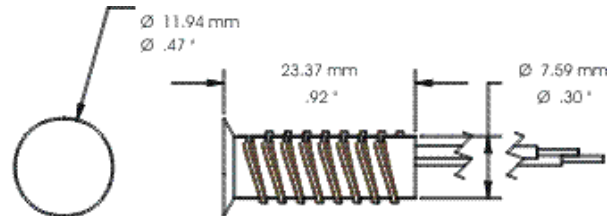
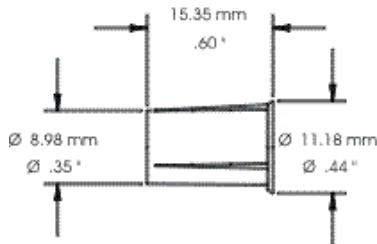

**2120-12**

3/8" Press to Fit Rib Switch Set

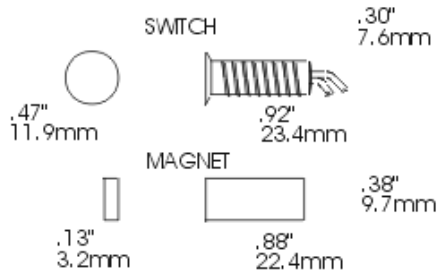

**N2120-12**

3/8" Press to Fit Rib Switch Set

# RECESSED 3/8" RIBBED SWITCH SET

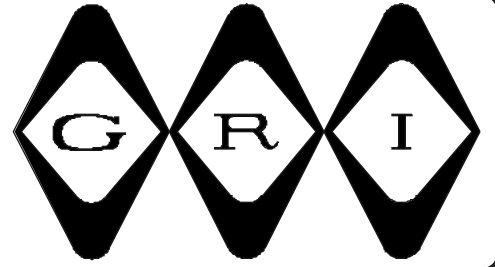

## 2120-12 Series

- ◆ Recessed Magnetic Contact
- ◆ Press To Fit     ◆ 12" #22AWG Leads
- ◆ Longer Leads, Zip Cord or Jacketed Cable Upon Request
- ◆ Hermetically Sealed     ◆ Plated Contacts Resist Sticking or Freezing
  - ◆ Built-in E.O.L. Resistors and Diodes Upon Request
  - ◆ Supervisory Loops Upon Request
  - ◆ Switches and Magnets Available Separately
- ◆ Color: White, Brown     ◆ Lifetime Warranty
- ◆ Protects Reed From Swelling Wood and Header Shift
  - ◆ Covers Over-drilled Holes     ◆ Self-centering
- ◆ Solves Angled Wire Path Problems     ◆ Ribbed Design Allows Secure Fit



2120-12

### PART NUMBERS

	<b>Closed Loop</b>	<b>Open Loop</b>	<b>SPDT</b>
Standard Gap 1/2" +	2120-12	2130-12	2140-12
Wide Gap 1" +	2120-12WG	2130-12WG	2140-12WG

GEORGE RISK INDUSTRIES, INC.  
G.R.I. PLAZA  
KIMBALL, NE 69145



MADE IN U.S.A.

TOLL-FREE 1-800-445-5218  
TOLL-FREE 1-800-523-1227  
(308) 235-4645  
FAX (308) 235-3561  
E-MAIL: [grisales@megavision.com](mailto:grisales@megavision.com)  
WEB SITE: [www.grisk.com](http://www.grisk.com)



# RECESSED 3/8" RIBBED SWITCH SET

## INSTALLATION APPLICATIONS:

The GRI 2120 Ribbed Switch, designed to complete a multi-task role, is a unique combination of special features and materials. The unusual ribbed outside diameter permits a secure mounting over a wide range of drilled hole sizes. The installer does not have to glue this recessed switch into a slightly oversized hole, as the flexible ribs conform as it is pressed into the wood. Self adjusting to fit the larger hole, the 2120 also centers itself to the coverage of the misdrilled hole. Picked especially for the 2120 Ribbed Switches, a new material with enhanced memory properties allows the ribbed "O" rings to flex enough to fit an undersized hole but still maintain a firm holding force in an oversized hole. This mix of features yields an additional bonus in that it provides a high degree of protection from crushing, such as that encountered when wood swells or headers shift. Finally, for installations utilizing an angled wire path away from the hole drilled for the switch barrel, the 2120 merely needs to be aligned with one flat side along the path drilled for the lead wire and press fit. The ribbed rings, not being continuous, simply adjust to the wire and allow for an easy and quick install.

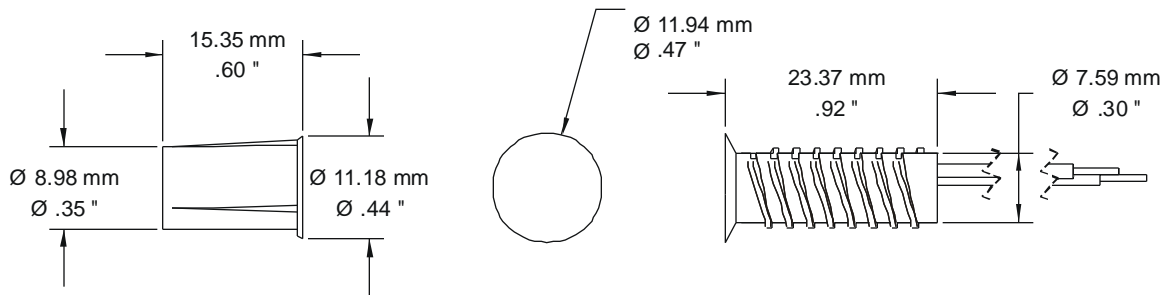

2120-12

## GRI products meet or exceed these minimum general specifications:

PART NUMBER	LOOP TYPE	SWITCH ELECTRICAL CONFIG.	REED FORM	MAXIMUM INITIAL CONTACT RESISTANCE (Ω)	MAXIMUM CONTACT RATING (W)	MAXIMUM SWITCHING VOLTAGE (VDC)	MAXIMUM SWITCHING CURRENT (A)
2120-12	Closed	N/O	A	.150	10	200	.500
2120-12WG	Closed	N/O	A	.150	10	200	.400
2130-12	Open	N/C	B	.140	5	175VDC	.250
2130-12WG	Open	N/C	B	.140	5	175VDC	.250
2140-12	Open/Closed	SPDT	C	.140	5	175VDC	.250
2140-12WG	Open/Closed	SPDT	C	.140	5	175VDC	.250

## WARRANTY:

Lifetime warranty against workmanship, material and factory defects.

*Contact your GRI Distributor or call:*

GEORGERISK INDUSTRIES, INC.  
GRI PLAZA  
KIMBALL, NE 69145



MADE IN U.S.A.

TOLL-FREE 1-800-445-5218  
TOLL-FREE 1-800-523-1227  
(308) 235-4645

FAX (308) 235-3561

E-MAIL: [grisales@megavision.com](mailto:grisales@megavision.com)

WEB SITE: [www.grisk.com](http://www.grisk.com)

# N SERIES SWITCH SETS

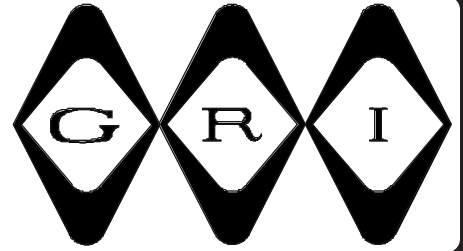

- ◆ Rare Earth Magnets Paired With Press To Fit Contacts
- ◆ Solves Problem Installs ◆ Time Saving Installations
- ◆ Nickel Plated To Protect From Chipping And Corrosion
- ◆ Use MM-600 With A Standard Gap Switch To Attain Wide Gap



N2120-12



N2020-TWG



N20RS-12

G.R.I.'s "Mighty Mag" contacts will assist in resolving the installer's problem of drilling into the new thinner vinyl windows. These rare earth magnets are less than 1/8" high and install fast and easily without worry about damage to the window itself. (Please see the Mighty Mag page in the accessories section of G.R.I.'s full line catalog for dimensions).

G.R.I.'s Mighty Magnets make use of a rare earth alloy which allows the size of the magnet to be significantly reduced while still retaining or improving the gap involved. These rare earth magnets can be mounted with the stainless steel mounting screws provided (MM-400 and MM-600) and/or double stick tape included in the bag, or may be glued into place.

**Note:** G.R.I. suggests using a silicone or clear nail polish sealant on the surface of installed rare earth magnets to prevent corrosion.

## PART NUMBERS:

N120T-12	N2020-T	N2120-12	N50RF-12
N120T-12WG	N2020-TWG	N2120-12WG	N50RF-12WG
N150-12	N20RS-12	N4473	N50RS-12
N150-12WG	N20RS-12WG	N4473WG	N50RS-12WG
N2020-12	N20RS-T	N50R-12	N5065
N2020-12WG	N20RS-TWG	N50R-12WG	

Other possible combinations including Open Loop and S.P.D.T. available or as Switch Only and Magnet Only.

GEORGE RISK INDUSTRIES, INC.  
G.R.I. PLAZA  
KIMBALL, NE 69145



MADE IN U.S.A.

TOLL-FREE 1-800-445-5218  
TOLL-FREE 1-800-523-1227  
(308) 235-4645  
FAX (308) 235-3561  
E-MAIL: [grisales@megavision.com](mailto:grisales@megavision.com)  
WEB SITE: [www.grisk.com](http://www.grisk.com)



# SWITCHES WITH RARE EARTH MAGNETS

Pair Switch with Magnet to get the following gaps:

Switch	Description	MM-25				
		MMR-25	MM-375	MM-10	MM-400	MM-600
S120T-12	3/4" Press Fit/Leads	3/8"+	1"+	Up to 1"	Up to 3/4"	1"+
S150-12	1/2" Press Fit/Leads	1/2"+	1 1/2"+	Up to 1"	3/4"+	1 1/2"+
S2020-12	3/8" Press Fit/Leads	Up to 1/2"	1"+	Up to 1"	1"+	1"+
S2020-T	3/8" Press Fit/Terminals	3/8"+	1"+	Up to 1"	Up to 3/4"	1"+
S20RS-12	3/8" Short Press Fit/Leads	Up to 3/8"	1"+	3/4"+	Up to 3/4"	Up to 1"
S20RS-T	3/8" Short Press Fit/Terminals	3/8"+	1"+	3/4"+	Up to 3/4"	Up to 1"
S2120-12	3/8" Ribbed Press Fit/Leads	5/8"+	1"+	Up to 1"	Up to 3/4"	1"+
S4473	3/4" Press Fit/Terminals	Up to 1/2"	1 1/4"+	Up to 1"	Up to 3/4"	1"+
S50R-12	1/4" Press Fit/Leads	Up to 1/2"	Up to 1 1/2"	1"+	3/4"+	Up to 1 1/4"
S50RF-12	1/4" Press Fit/Flanged/Leads	Up to 1/2"	Up to 1 1/2"	1"+	Up to 3/4"	Up to 1 1/4"
S50RS-12	1/4" Short Press Fit/Leads	Up to 3/8"	1"+	3/4"+	Up to 1/2"	Up to 1 1/4"
S5065	3/8" Press Fit/Leads	1/2"+	1"+	1"+	Up to 1"	Up to 1 1/4"

Magnet orientation will affect operation of switch. Please confirm operation prior to installation.

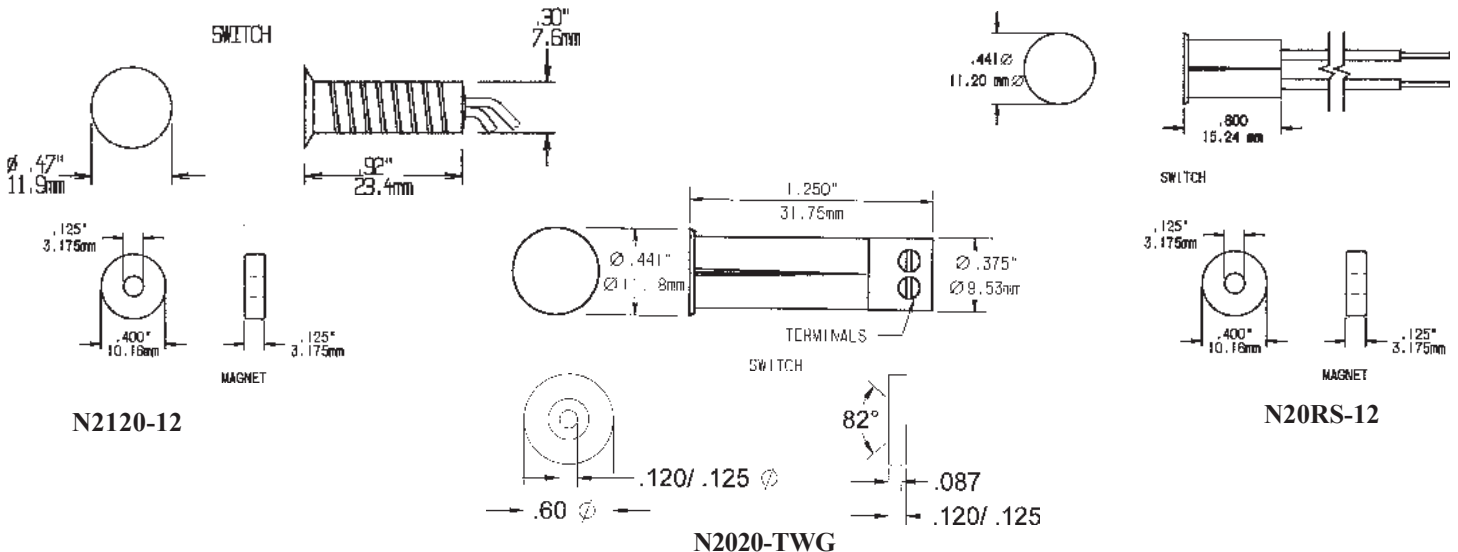

**WARRANTY:**

Lifetime warranty against workmanship, material and factory defects.

**CONTACT YOUR G.R.I. DISTRIBUTOR OR CALL:**

GEORGE RISK INDUSTRIES, INC.  
GRI PLAZA  
KIMBALL, NE 69145



MADE IN U.S.A.

TOLL-FREE 1-800-445-5218  
TOLL-FREE 1-800-523-1227  
(308) 235-4645  
FAX (308) 235-3561  
E-MAIL: [grisales@megavision.com](mailto:grisales@megavision.com)  
WEB SITE: [www.grisk.com](http://www.grisk.com)