



2GIG-FT1-345

FLOOD AND TEMPERATURE DETECTOR

INSTALLATION INSTRUCTIONS

The 2GIG-FT1-345 is a fully supervised, tamper protected one-way 345 MHz sensor. It will monitor the ambient temperature and/or will detect a wet/dry flood condition. The sensor reports wet/dry conditions and temperature to the panel.

Flood Conditions

Once the sensor probe detects the presence of water for three (3) minutes, the integral transmitter will send a wet alarm transmission to the panel. The probe will also send a restore (dry) report when the presence of liquid is no longer detected by the flood probe for three (3) minutes. For flood reporting the sensor requires the installation of the supplied external flood probe. The sensor is capable of detecting clean or dirty fresh water, salt water, or tap water.

Temperature Conditions

Heat:

1. If the temperature is more than 95° F (35°C) for five (5) minutes, the sensor will send a loop 2 transmission.
2. If the temperature is less than 95°F (35°C) for five (5) minutes, the sensor will send a loop 2 clear.

Cold:

1. If the temperature is less than 41°F (5°C) for five (5) minutes, the sensor will send a loop 3 transmission.
2. In the temperature is more than 41°F (5°C) for five (5) minutes, the sensor will send a loop 3 clear.

Contents

Verify that the package includes the following:

- 1—2GIG Flood/Temperature Sensor
- 1—Sensor Mounting Plate
- 1—3V Lithium Battery (Panasonic CR15H270 uninstalled)
- 3—3/8" Phillips Screws
- 1—Double Stick Tape Strip
- 1—Probe Mounting Plate

Installation Tools Required

- Phillips Screwdriver

Figure 1. Temperature/Flood Sensor Contents

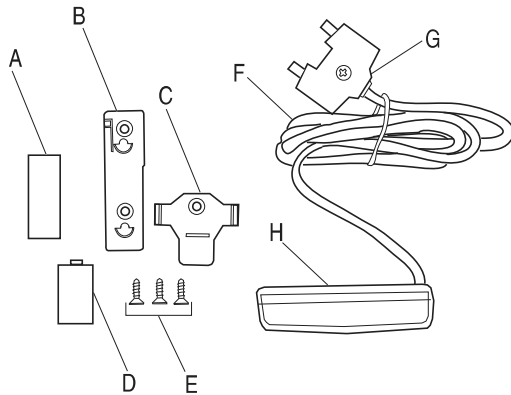

- A Double Stick Tape Strip
- B Sensor Mounting Plate
- C Probe Mounting Plate
- D 3V Lithium Battery
- E Phillips Screws (3/8")
- F Flood Probe Cord
- G Flood Probe
- H Transmitter with Integral Temperature Sensor

Installing and Replacing Battery

Open Sensor Case as show in Figures 2 and 3. Install or replace battery.

Figure 2. Opening Sensor Case

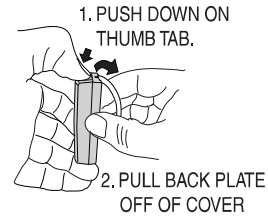

Grip the base of the sensor case. Place thumb on tab and push down until sensor case separates.

Figure 3. Separate Sensor Case

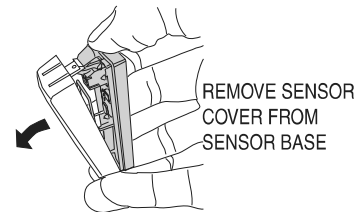
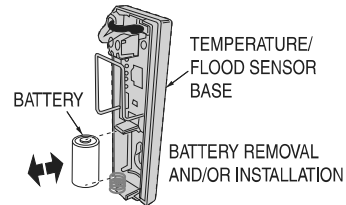

Figure 4. Installing New Battery



Installing a New Battery and System Programming

NOTE: Do not install battery until panel is in Sensor Programming Mode.

1. Place panel in Sensor Programming mode
2. Insert battery
3. Close sensor

Replacement Battery Installation:

NOTE: If battery has been previously installed

1. Remove battery and dispose of (meeting state regulations)
2. Wait two (2) seconds
3. Replace battery
4. Close sensor

Installing/Mounting Flood/Temperature Sensor

The 2GIG-FT1-345 Flood and Temperature Sensor includes two methods of installation:

1. Double Stick Tape Installation (See Figure 5).
2. Screw/Mounting Plate Installation (See Figure 6).

It is strongly recommended that the Flood/Temperature Sensor be mounted using screws (provided) and Mounting Plate (provided).

Figure 5. Double Stick Tape Mounting Sensor Mounting Plate

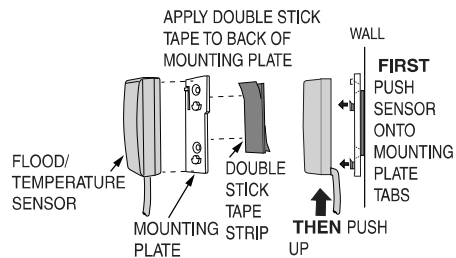

2GIG Flood & Temperature Control | Instruction Manual

Figure 6. Screw Mounting Sensor Mounting Plate

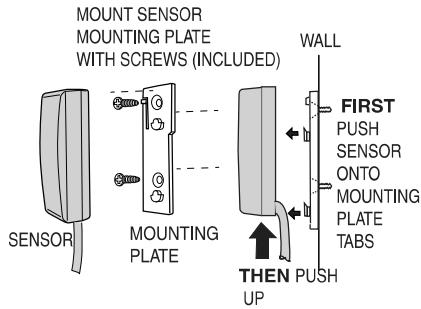

Removing Flood/Temperature Sensor from Mounting Plate

If Flood/Temperature Sensor needs to be removed from the wall (for changing out battery), open sensor case (See Figures 2 and 3). Remove sensor, then Press Down on release tab with flathead screwdriver and pull sensor UP.

Figure 7. Removing Sensor from Wall/Mounting Plate

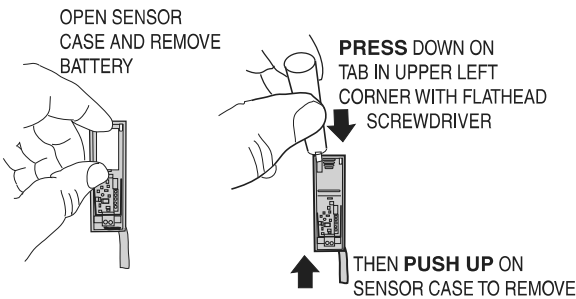

Mounting Flood Probe

The Flood Probe must be mounted at floor level using the Probe Mounting Plate and screw (included) mount as shown in Figure 8.

Figure 8. Mounting Probe Mounting Plate at Floor Line

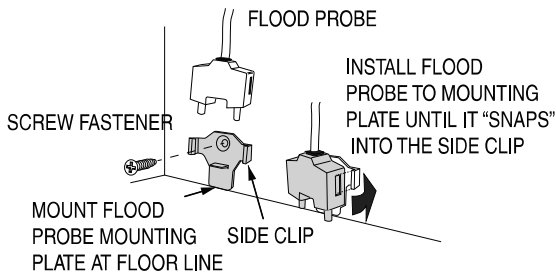

Flood/Temperature Specifications

Operating Temperature:	32° to 120° F (0° to 49° C)
Operating Rel. Humidity:	5 to 95%, non-condensing
Operating Frequency:	345 MHz
Battery Type:	CR2 3V lithium battery
Projected Battery Life:	5 Years

REGULATORY INFORMATION

This equipment has been tested and found to comply with the limits for Class B Digital Device, pursuant to Part 15 of the FCC Rules. These limits are designed to provide reasonable protection against harmful interference in a residential installation. This equipment generates and can radiate radio frequency energy and, if not installed and used in accordance with the instructions, may cause harmful interference to radio communications. However, there is no guarantee that interference will not occur in a particular installation. If this equipment does cause harmful interference to radio or television reception, which can be determined by turning the equipment off and on, the user is encouraged to try to correct the interference by one or more of the following measures.

Reorient or relocate the receiving antenna

Increase the separation between the equipment and receiver

Connect the equipment into an outlet on a circuit different from that to which the receiver is connected

Consult the dealer or an experienced radio/TV technician for help.

Any changes or modifications not expressly approved by the party responsible for compliance could void the user's authority to operate the equipment.

Le présent appareil est conforme aux CNR d'Industrie Canada applicables aux appareils radio exempts de licence. L'exploitation est autorisée aux deux conditions suivantes: (1) l'appareil ne doit pas produire de brouillage, et (2) l'utilisateur de l'appareil doit accepter tout brouillage radioélectrique subi, même si le brouillage est susceptible d'en compromettre le fonctionnement.

FCC COMPLIANCE STATEMENT

This device complies with FCC Rules and Regulations as Part 15 devices as well as Industry Canada license exempt RSS Rules and Regulations. Operation is subject to the following two (2) conditions: This device may not cause harmful interference. This device must accept any interference received, including interference that may cause undesired operation.

LIMITED WARRANTY

This Nortek Security & Control LLC product is warranted against defects in material and workmanship for two (2) years. This warranty extends only to wholesale customers who buy direct from Nortek Security & Control LLC or through Nortek Security & Control normal distribution channels. Nortek Security & Control does not warrant this product to consumers. Consumers should inquire from their selling dealer as to the nature of the dealer's warranty, if any.

There are no obligations or liabilities on the part of Nortek Security & Control for consequential damages arising out of or in connection with use or performance of this product or other indirect damages with respect to loss of property, revenue, or profit, or cost of removal, installation, or reinstallation. All implied warranties for functionality, are valid only until the warranty expires. This Nortek Security & Control Warranty is in lieu of all other warranties expressed or implied.

Nortek Security & Control LLC
1950 Camino Vida Roble, Suite 150
Carlsbad, CA 92008-6517 USA



For technical support in the USA and Canada:

855-2GIG-TECH (855-244-4832)

Email: 2gigtechsupport@nortek.com

Visit www.nortekcontrol.com for technical support hours of operation

For technical support outside of the USA and Canada:

Visit dealer.2gig.com for a list of distributors in your region

10008993 A