

# ALTV244UL Series

## CCTV Power Supplies

### Models Include:

#### ALTV244UL

- 24VAC @ 3.5A (85VA) or 28VAC @ 3A (85VA).
- Four (4) Fuse Protected Outputs.

#### ALTV244ULX

- 24VAC @ 3.5A (85VA) or 28VAC @ 3A (85VA).
- Four (4) Fuse Protected Outputs.

#### ALTV244175UL

- 24VAC @ 7A (175VA) or 28VAC @ 10A (300VA).
- Four (4) Fuse Protected Outputs.

#### ALTV244ULCB

- 24VAC @ 3.5A (85VA) or 28VAC @ 3A (85VA).
- Four (4) PTC Protected Outputs.

#### ALTV244175ULCB

- 24VAC @ 7A (175VA) or 28VAC @ 10A (300VA).
- Four (4) PTC Protected Outputs.

## Installation Guide



Rev. 040506



More than just power.™

Installing Company: \_\_\_\_\_ Service Rep. Name: \_\_\_\_\_

Address: \_\_\_\_\_ Phone #: \_\_\_\_\_

## Overview:

Altronix ALTV244UL Series CCTV Power Supplies provide 24VAC or 28VAC distributed via four (4) fuse or PTC protected outputs for powering CCTV cameras, heaters and other video accessories.

### Four (4) Output ALTV244UL Reference Chart:

Altronix Model Number	Output Voltage	Total Output Current (Power)	Number of Outputs	PTC Protected Outputs (Class 2 power-limited for Dry locations - Class 3 for Wet locations) (auto-resettable)	Fuse Protected Class 1 Outputs	Individual Output Current (max per output, not to exceed total output current)	Fuse Ratings	Main Fuse Ratings	Primary In-line Fuse Ratings	115VAC 60Hz Input Current	Agency Listings
ALTV244UL	24VAC	3.5A	4	-	✓	3.5A	3.5A	5A/250V	3.5A/250V	0.9A	
	28VAC	3A						5A/250V	3.5A/250V		
ALTV244ULX	24VAC	3.5A	4	-	✓	3.5A	3.5A	5A/250V	3.5A/250V	0.9A	
	28VAC	3A						5A/250V	3.5A/250V		
ALTV244ULCB	24VAC	3.5A	4	✓	-	2.5A	-	5A/250V	3.5A/250V	0.9A	
	28VAC	3A						5A/250V	3.5A/250V		
ALTV244175UL	24VAC	7A	4	-	✓	3.5A	3.5A	10A/250V	-	1.76A	
	28VAC	6.25A						10A/250V	-		
ALTV244175ULCB	24VAC	7A	4	✓	-	2.5A	-	10A/250V	-	1.76A	
	28VAC	6.25A						10A/250V	-		

## Specifications:

### Agency Listings:

- UL Listed for Commercial CCTV Equipment (UL 2044).
- CUL Listed - CSA Standard C22.2 No.1-98, Audio, Video and Similar Equipment.
- CE European Conformity.

### Input:

- 115VAC, 50/60Hz.

### Output:

- Four (4) fuse or PTC protected outputs.
- 24VAC or 28VAC output.
- Outputs are rated @ 3.5A (fused) or 2.5A (PTC).
- Surge suppression.

### Features:

- Power ON/OFF switch (ALTV244UL, ALTV244ULX, and ALTV244ULCB).

### Features (cont'd):

- Illuminated power disconnect circuit breaker with manual reset (ALTV244175UL and ALTV244175ULCB).
- Unit maintains camera synchronization.
- Ease of installation saves time & eliminates costly labor.
- Spare fuses included (on fuse protected models).

### Enclosure Dimensions (H x W x D):

- **ALTV244UL, ALTV244ULCB**  
8.5" x 7.5" x 3.5" (215.9mm x 190.5mm x 88.9mm).
- **ALTV244175UL, ALTV24175ULCB**  
12" x 7.5" x 4.5" (304.8mm x 190.5mm x 114.3mm).
- **ALTV244ULX**  
13.5" x 13" x 3.25"  
(342.9mm x 330.2mm x 82.6mm).

## Installation Instructions:

1. Mount unit in the desired location. Mark and predrill holes in the wall to line up with the top two keyholes in the enclosure. Install two upper fasteners and screws in the wall with the screw heads protruding. Place the enclosure's upper keyholes over the two upper screws, level and secure. Mark the position of the lower two holes. Remove the enclosure. Drill the lower holes and install the three fasteners. Place the enclosure's upper keyholes over the two upper screws. Install the two lower screws and make sure to tighten all screws (*Enclosure Dimensions, pgs. 10-12*). Secure enclosure to earth ground.
2. Set power switch on power distribution board marked [PD] to OFF position for models ALTV244UL, ALTV244ULX or ALTV244ULCB (*Figs. 1-3, pgs. 4-6*).
3. All units are factory set for 24VAC operation. For 28VAC operation adjust unit prior to applying power as follows: Remove wires marked [24V] and [28V] from terminals marked [P] and [S]. Connect wire marked [28V] to terminal marked [P] and connect wire marked [24V] to terminal marked [S].  
**Note: ALTV244ULCB set for 28VAC operation is not Class 2 Rated, not power-limited.**
4. Connect AC power to the black and white flying leads of the transformer (*Figs. 1-5, pgs. 4-8*). Secure green lead to earth ground. Use 18 AWG or larger gauge for all power connections.  
**Keep power-limited (PTC protected outputs only) wiring separate from non power-limited wiring. Minimum 0.25" spacing must be provided. Use separate knockouts.**
5. Set power switch on power distribution board marked [PD] to ON position for models ALTV244UL, ALTV244ULX or ALTV244ULCB (*Figs. 1-3, pgs. 4-6*).
6. Measure output voltage before connecting devices. This helps avoiding potential damage. Terminals marked [1P - 4P] are of the same polarity.  
**CAUTION: Determine the maximum operating voltage of the equipment being powered before adjusting the output voltage.**
7. Set power switch on power distribution board marked [PD] to OFF position for models ALTV244UL, ALTV244ULX or ALTV244ULCB (*Figs. 1-3, pgs. 4-6*).
8. Connect devices to the terminals marked [1P] - [1N] through [4P] - [4N] on PD4 or PD4CB board (*Figs. 1-5, pgs. 4-8*), carefully observing polarity.
9. Set power switch on power distribution board marked [PD] to ON position for models ALTV244UL, ALTV244ULX or ALTV244ULCB (*Figs. 1-3, pgs. 4-6*).
10. Green LED will illuminate when power is present.
11. Upon completion of the wiring, secure enclosure door with screws (supplied).  
Installation of a cam lock is optional.  
**Caution: Equipment to be installed/serviced by authorized/trained personnel only. Shut branch circuit power before installing/servicing equipment.**

**WARNING:** To reduce the risk of fire or electric shock, do not expose the unit to rain or moisture. This installation should be made by qualified service personnel and should conform to the National Electrical Code and all local codes. Use 75°C or higher rated UL insulated wiring for connecting the unit to the mains. Replace fuses with the same type and rating (refer to Four (4) Output ALTV244UL Reference Chart, pg. 2).

## Terminal Identification:

### PD4/PD4CB - Distribution Module

1P - 4P	AC output.
1N - 4N	AC output.



The lightning flash with arrowhead symbol within an equilateral triangle is intended to alert the user to the presence of an insulated DANGEROUS VOLTAGE within the product's enclosure that may be of sufficient magnitude to constitute an electric shock.



The exclamation point within an equilateral triangle is intended to alert the user to the presence of important operating and maintenance (servicing) instructions in the literature accompanying the appliance.



**CAUTION**  
**RISK OF ELECTRIC SHOCK**  
**DO NOT OPEN**



**CAUTION:** To reduce the risk of electric shock do not open enclosure. There are no user serviceable parts inside. Refer servicing to qualified service personnel.

Fig. 1 - ALTV244UL

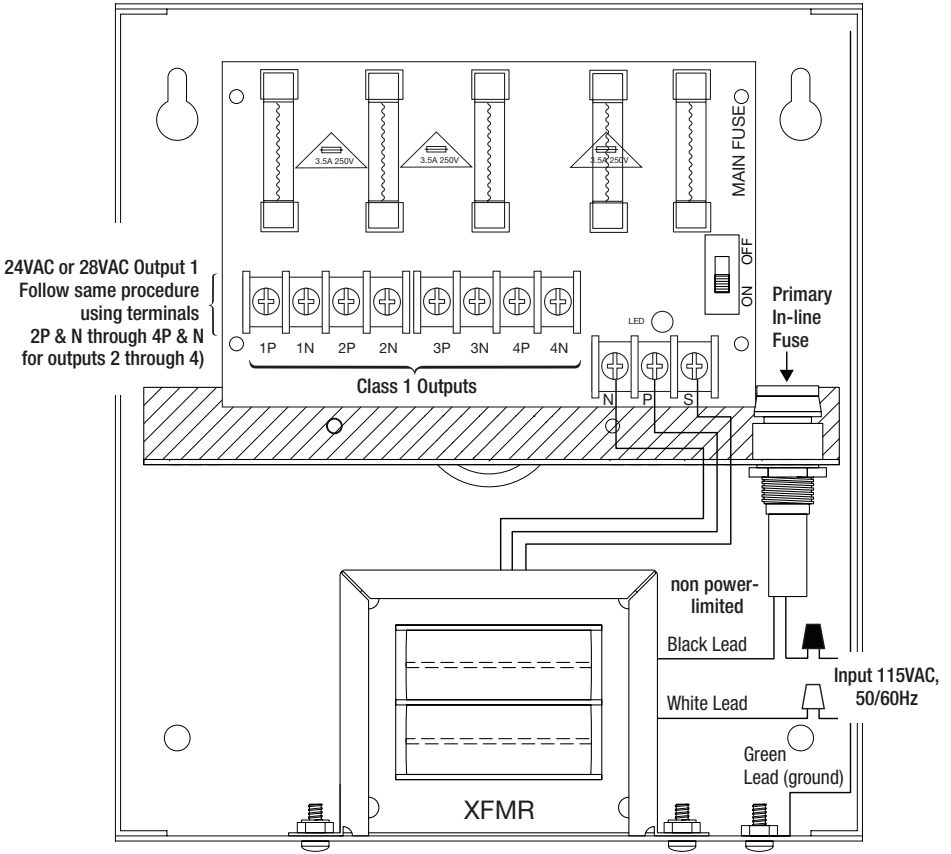

### Voltage Selection Configuration

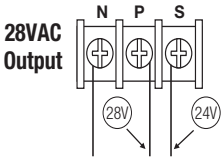
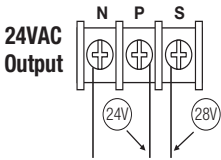
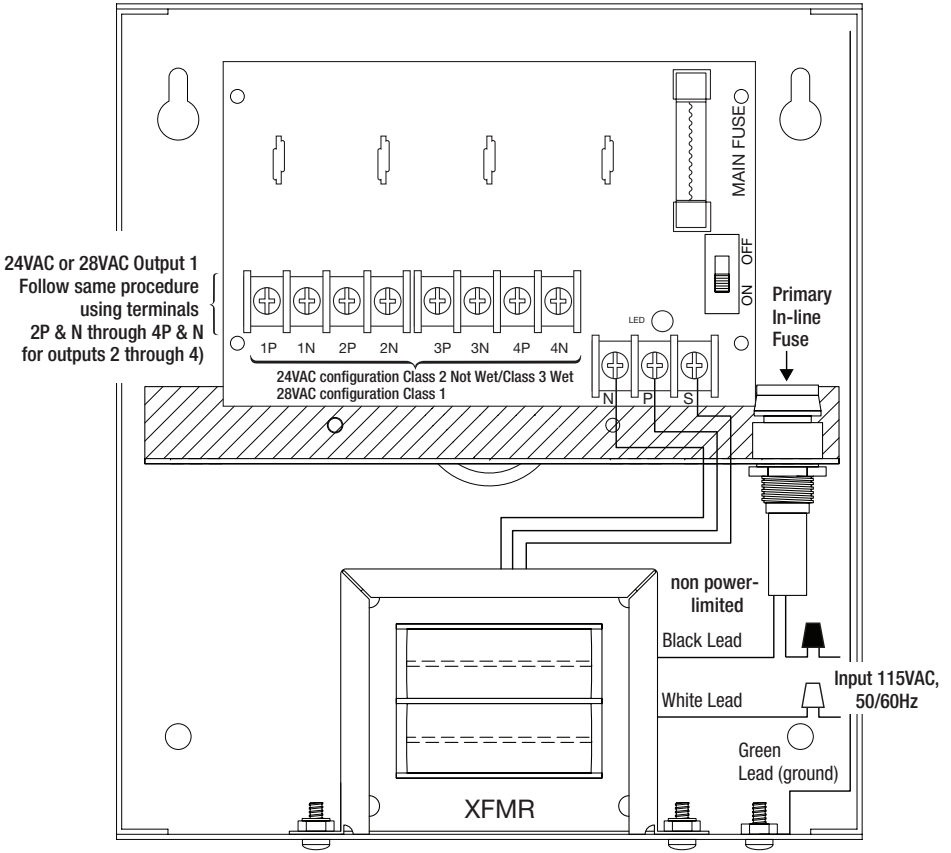

Fig. 2 - ALTV244ULCB



**Voltage Selection  
Configuration**

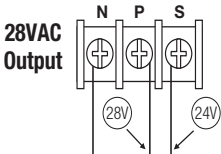
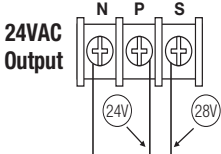
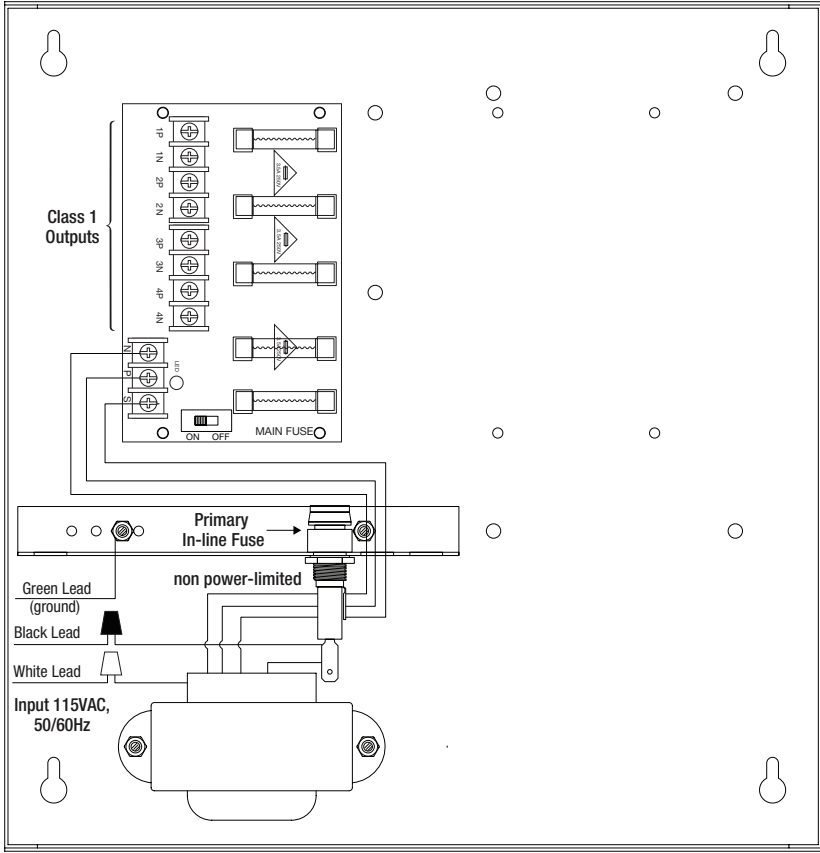

Fig. 3 - ALTV244ULX



**Voltage Selection Configuration**

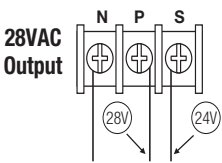
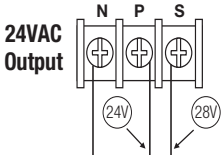
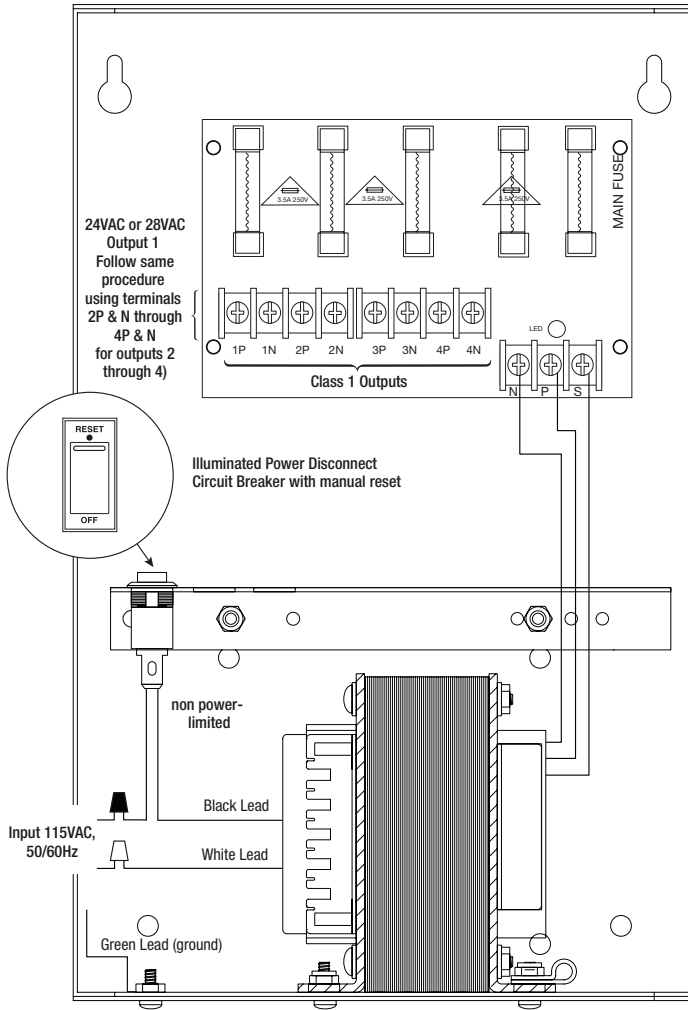

Fig. 4 - ALTV244175UL



### Voltage Selection Configuration

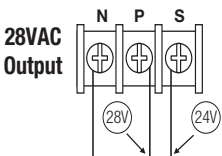
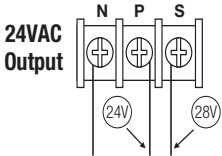
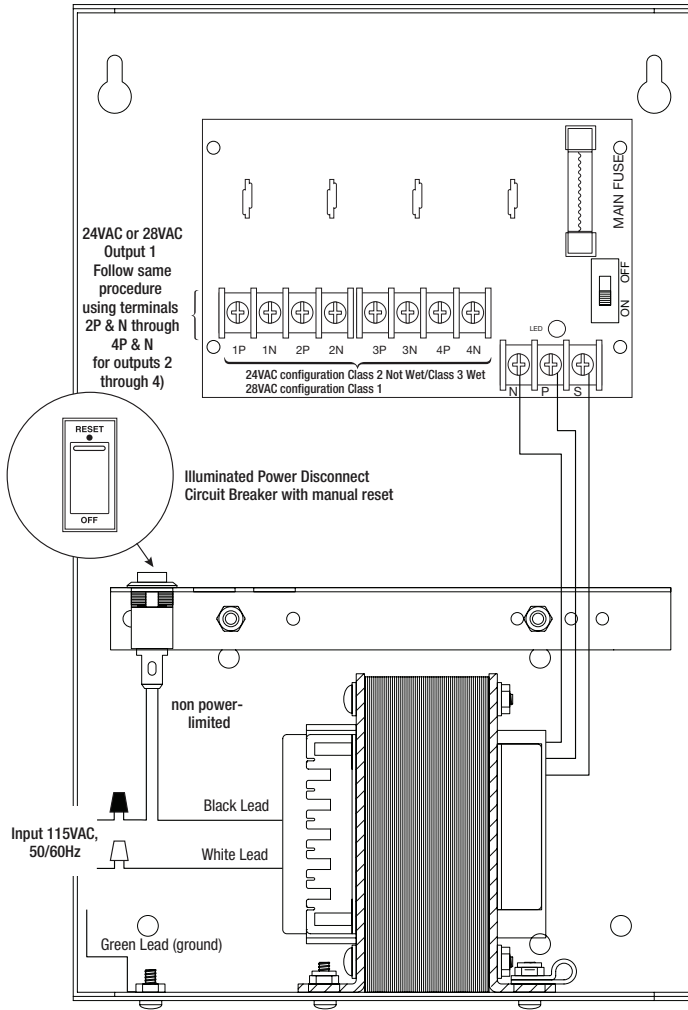
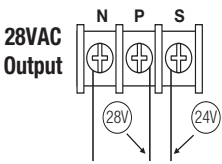
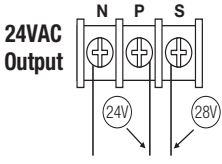

Fig. 5 - ALT244175ULCB



**Voltage Selection Configuration**





## Notes:

# Enclosure Dimensions (H x W x D) for:

- ALTV244UL
- ALTV244ULCB

8.5" x 7.5" x 3.5" (215.9mm x 190.5mm x 88.9mm)

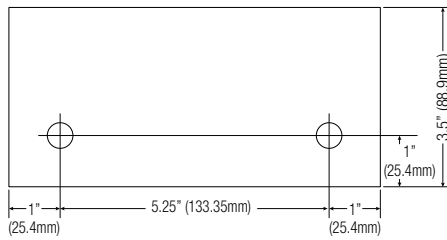
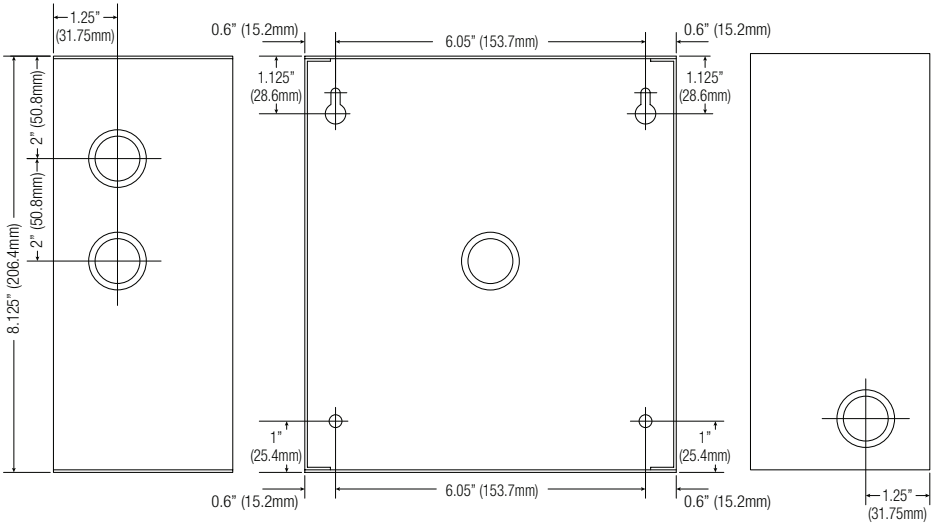
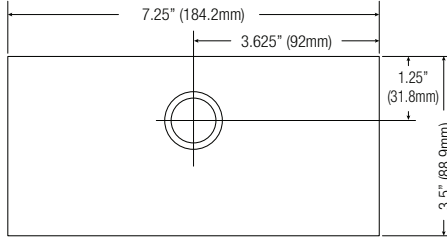

# Enclosure Dimensions (H x W x D) for:

## • ALTV244ULX

13.5" x 13" x 3.25" (342.9mm x 330.2mm x 82.6mm)

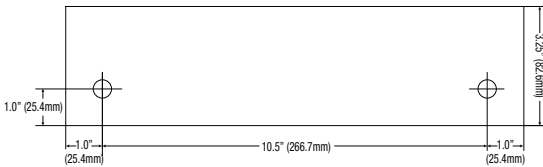
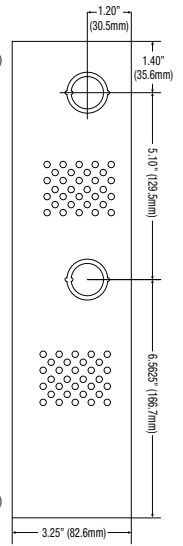
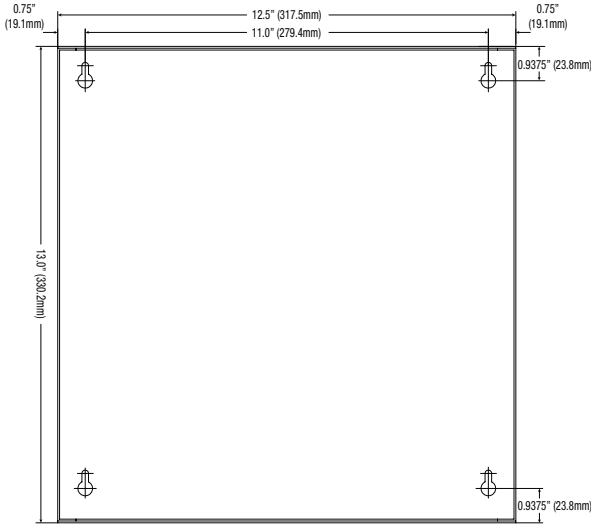
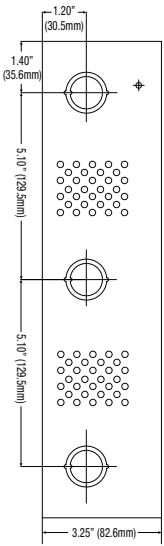
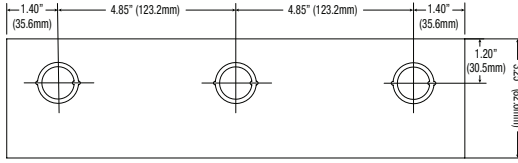

# Enclosure Dimensions (H x W x D) for:

- ALTV244175UL
- ALTV244175ULCB

12" x 7.5" x 4.5" (304.8mm x 190.5mm x 114.3mm)

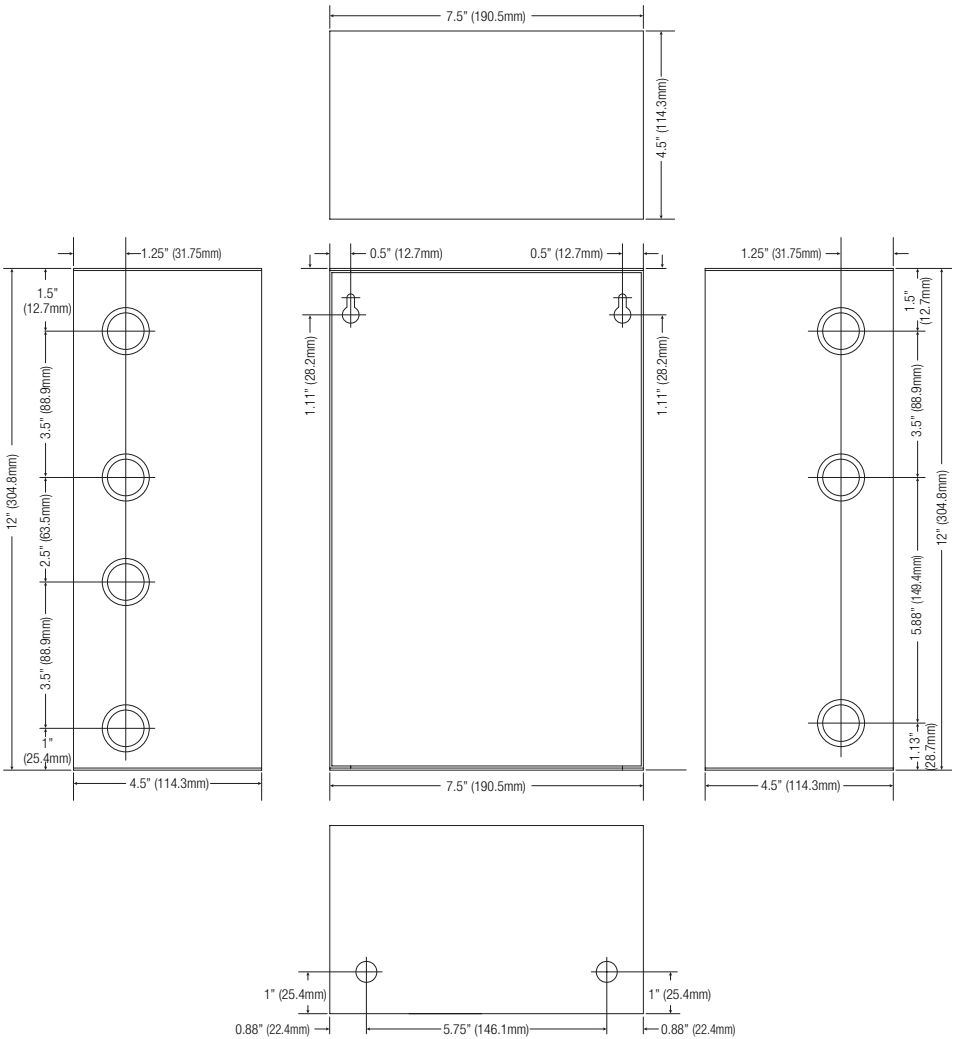

Altronix is not responsible for any typographical errors.

140 58th Street, Brooklyn, New York 11220 USA | phone: 718-567-8181 | fax: 718-567-9056  
website: [www.altronix.com](http://www.altronix.com) | e-mail: [info@altronix.com](mailto:info@altronix.com) | Lifetime Warranty  
IALTV244UL Series I16U

