



AVC-TE21F28

NDA
COMPLIANT | CE | FC

2MP HD-TVI FIXED TURRET CAMERA

OVERVIEW

- 2MP (1920x1080)
- HD-TVI / CVI / AHD / CVBS (Analog)
- True Day & Night ICR
- Fixed 2.8mm Lens
- Easy-to-Use DIP Switch to Change Formats
- 2D DNR, 3D DNR, BLC, FLC
- Smart IR Illumination Up to 66ft
- IP67 ingress protection
- DC12V

DIMENSIONS

Unit : inch(mm)

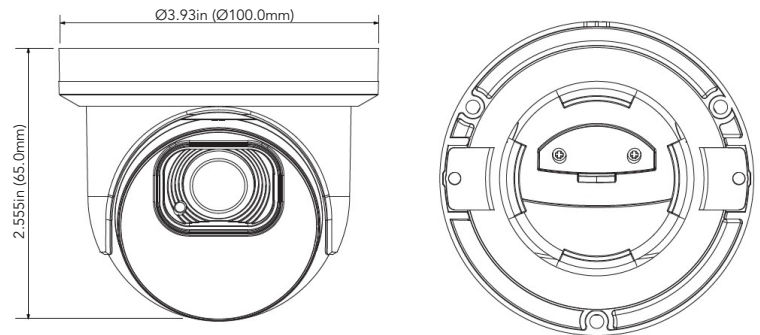

OPTIONAL ACCESSORIES

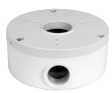

AVM-JB-BE-S1
JUNCTION BOX



AVM-CWM-EV-S1
COMPACT
WALL MOUNT



AVM-HWM-E-S1
WALL MOUNT
WITH JUNCTION BOX



AVM-HCM-E-S1
CEILING MOUNT
WITH JUNCTION BOX



AVM-POM-A1
POLE
MOUNT BRACKET



AVM-CRM-A1
CORNER
MOUNT BRACKET

SPECIFICATIONS

CAMERA	
Image Sensor	1/2.7" Progressive Scan CMOS
Resolution	2MP
Image Size	1920x1080
Video Output	1 channel BNC Video Output
Image System	PAL / NTSC
Electronic Shutter	1/15s to 1/50,000s
IR Distance	Up to 66ft.
Video Formats	HD-TVI / ADH / CVI / CVBS (Analog)
Frame Rate	HD-TVI / ADH / CVI / CVBS (Analog): 30 FPS
Min. Illumination	0.01 lux @ F1.2 (AGC ON), 0 lux with IR ON
Lens	Fixed 2.8mm Lens
Lens Mount	M12
Horizontal Field of View	105.41°
S/N Ratio	39dB
Function Control	OSD, Control over Coax (UTC)
IMAGE	
Day & Night	EXT / Color / BW (Black and White)
WDR	No
Digital NR	Yes (2D DNR / 3D DNR)
Auto Gain Control (AGC)	Yes
Auto White Balance (AWB)	Yes
Backlight Compensation (BLC)	Yes
Edge Brightness Compensation	Yes
Defog	No
HLC	No
FLC	Yes
Sharpness	Yes
Mirror Image	Yes
Smart IR (Anti-SAT)	Yes
Image Setting	Yes
Defect Correction	Auto / Manual
GENERAL	
Angle Adjustment	Manual Adjustment
Input Voltage	DC 12V (±10%)
Power Consumption	Maximum 3W
Ingress Protection	IP67
Working Environment	-22°~131°F (-30°~55°C)
Dimensions	Ø3.93x2.55in (Ø100x65mm)