



Installation Guide

Guía de Instalación

Guide d'installation

Guia de Instalação

Indoor Access Point

CONTENTS

English.....	01
Español.....	05
Français.....	09
Português.....	13

Note: Images may differ from your actual product.

Network Topology

A typical network topology for the AP is shown below.

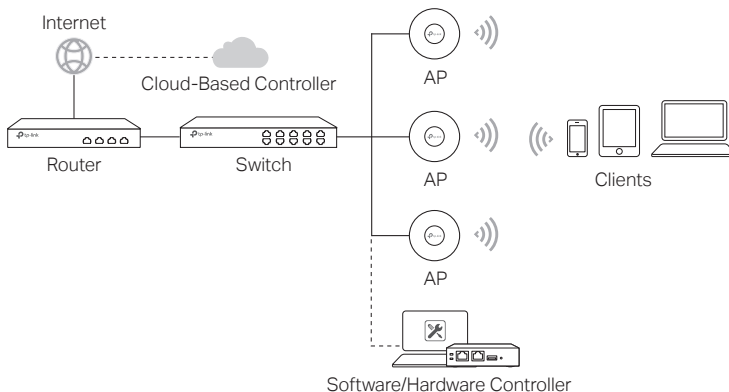

Some APs can be configured and monitored centrally via a controller. For details, refer to the product specifications and the manual for the relevant product or controller. You can get the controller from <https://www.tp-link.com> or contact the sales staff.

Hardware Installation

■ Option 1: Ceiling Mounting

Follow the steps below to install the AP with the provided accessories:

Note: The mounting bracket and the accessories (quantity and size) may vary by product.



Washers



Pan-head Screws



Wing Nuts

- 1 Remove the ceiling tile.

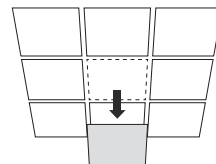

- 2 Place the mounting bracket in the center of the ceiling tile. Mark positions for the screw holes and a position for the Ethernet cable hole. Drill holes for the screws and a hole for the Ethernet cable at the marked positions.

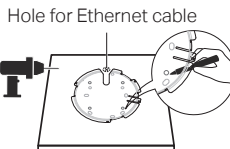

- 3 Secure the mounting bracket to the ceiling tile using pan-head screws, washers and wing nuts.

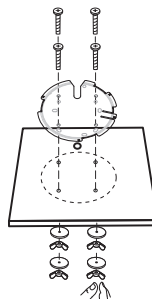

- 4 Feed the Ethernet cable through the hole and set the ceiling tile back into place.

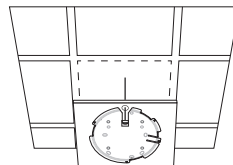

- 5 Connect the Ethernet cable to the Ethernet port. Attach the AP to the mounting bracket by aligning the arrow mark on the AP with the arrow mark on the mounting bracket, then rotate the AP until it is locked into place.

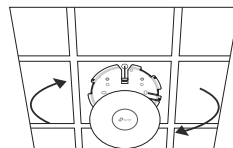

■ Option 2: Wall Mounting

Follow the steps below to install the AP with the provided accessories:

Note: The mounting bracket and the accessories (quantity and size) may vary by product.



Plastic Wall Anchors



Self-tapping Screws

- 1** If your Ethernet cable feeds through the wall, position the mounting bracket and feed the Ethernet cable. Mark positions for the screw holes and then drill holes at the marked positions.

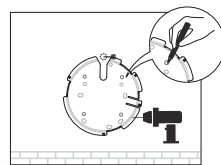

- 2** Insert the plastic wall anchors into the holes.

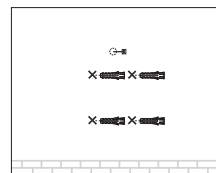

- 3** Secure the mounting bracket to the wall by driving the self-tapping screws into the anchors. Make sure that the shoulders of the mounting bracket are on the outside.

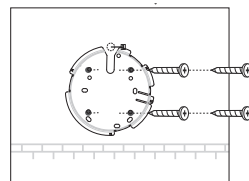

- 4** Connect the Ethernet cable to the Ethernet port on the AP.

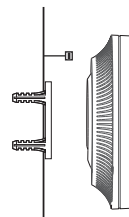

- 5** Attach the AP to the mounting bracket by aligning the arrow mark on the AP with the arrow mark on the mounting bracket, then rotate the AP until it is locked into place.

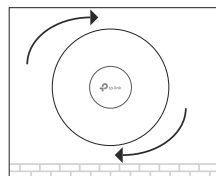

Power Supply

■ Power via PSE Device or Power Adapter

Some APs can be powered via the power adapter or the PSE device (such as a PoE switch) which complies with Power Source Class 2 (PS2) or Limited Power Source (LPS) of IEC 62368-1.

Note: Availability depends on the actual product. Please refer to the product specifications.

Via PoE Switch

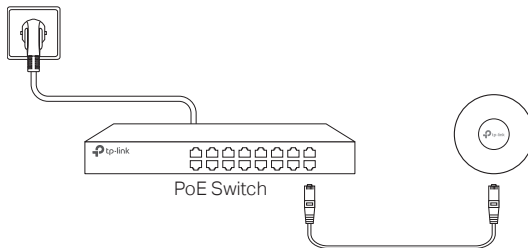

Via Power Adapter

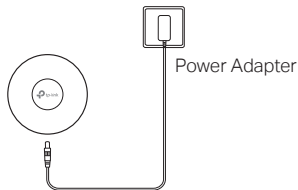

■ Power via PoE Adapter

Some APs can be powered via the PoE adapter.

Note: Availability depends on the actual product. Please refer to the product specifications.

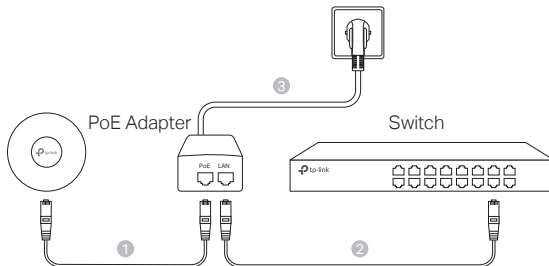

Nota: La imagen puede diferir del producto real.

Topología de la red

A continuación se muestra una topología de red típica para el AP.

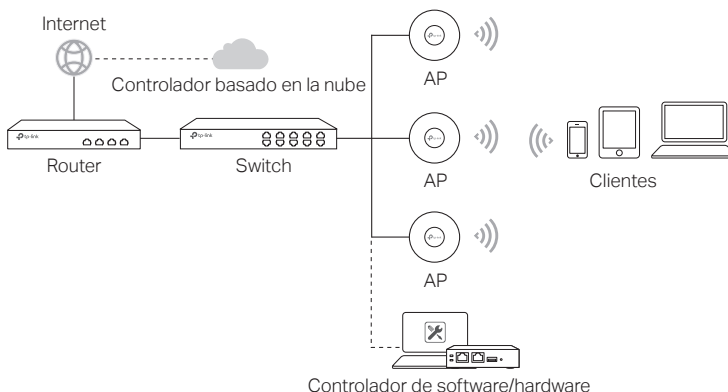

Algunos AP se pueden configurar y monitorear de forma centralizada a través de un controlador. Para obtener más información, consulte las especificaciones del producto y el manual del producto o controlador correspondiente. Puede obtener el controlador en <https://www.tp-link.com> o comunicarse con el personal de ventas.

Instalación de hardware

■ Opción 1: Montaje en el techo

Siga los siguientes pasos para instalar el AP con los accesorios suministrados:

Nota: El soporte de montaje y los accesorios (cantidad y tamaño) pueden variar según el producto.



Arandelas



Tornillos de cabeza plana



Tuercas de mariposa

- 1 Retire la placa de techo.

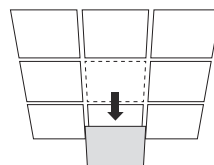

2

Coloque el soporte de montaje en el centro de la placa del techo. Marque las posiciones para los orificios de los tornillos y una posición para el orificio del cable Ethernet. Taladre orificios para los tornillos y un orificio para el cable Ethernet en las posiciones marcadas.

Orificio para cable Ethernet

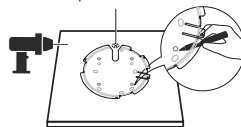

3

Fije el soporte de montaje a la placa del techo utilizando tornillos de cabeza, arandelas y tuercas de mariposa.

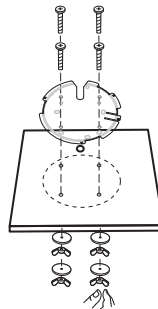

4

Introduzca el cable Ethernet a través del orificio y vuelva a colocar el mosaico de techo en su lugar.

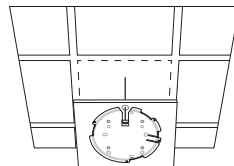

5

Conecte el cable de red al puerto ETHERNET. Coloque el AP en el soporte de montaje alineando la marca de flecha en el AP con la marca de flecha en el soporte de montaje, luego gire el AP hasta que quede asegurado en su lugar.

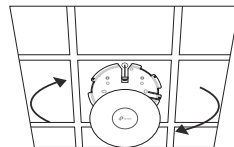

■ Opción 2: Montaje en pared

Siga los siguientes pasos para instalar el AP con los accesorios suministrados:

Nota: El soporte de montaje y los accesorios (cantidad y tamaño) pueden variar según el producto.



Anclajes de pared de plástico



Tornillos autorroscantes

- 1** Si el cable Ethernet atraviesa la pared, coloque el soporte de montaje e introduzca el cable Ethernet. Marque las posiciones para los agujeros de los tornillos y taladre agujeros en las posiciones marcadas.

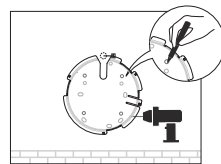

- 2** Inserte los anclajes de pared de plástico en los orificios.

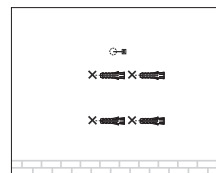

- 3** Asegure el soporte de montaje a la pared al empujar los tornillos autorroscantes en los anclajes. Asegúrese de que las pestañas del soporte de montaje estén en el exterior.

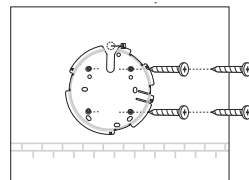

- 4** Conecte el cable de red al puerto ETHERNET del AP.

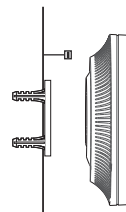

- 5** Coloque el AP en el soporte de montaje alineando la marca de flecha en el AP con la marca de flecha en el soporte de montaje, luego gire el AP hasta que quede bloqueado en su lugar.

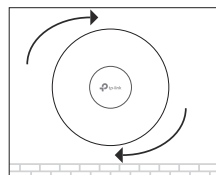

Fuente de alimentación

■ Alimentación a través del dispositivo PSE o adaptador de alimentación

Algunos AP pueden alimentarse a través del adaptador de corriente o del dispositivo PSE (como un switch PoE) que cumple con la clase de fuente de alimentación 2 (PS2) o la fuente de alimentación limitada (LPS) de IEC 62368-1.

Nota: La disponibilidad depende del producto real. Consulte las especificaciones del producto.

Via Switch PoE

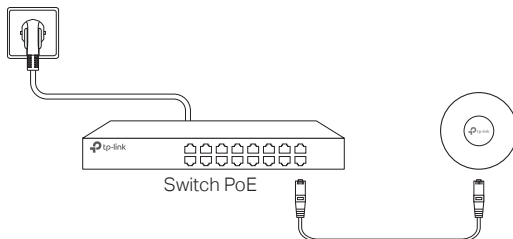

Vía adaptador de corriente



■ Alimentación a través del adaptador POE

Algunos AP pueden alimentarse a través del adaptador PoE.

Nota: La disponibilidad depende del producto real. Consulte las especificaciones del producto.

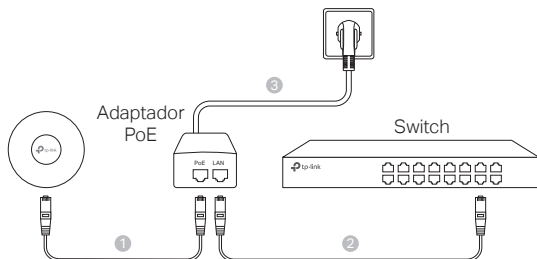

Remarque: illustrations non contractuelles.

Topologie réseau

Une topologie réseau typique est présentée ci-dessous.

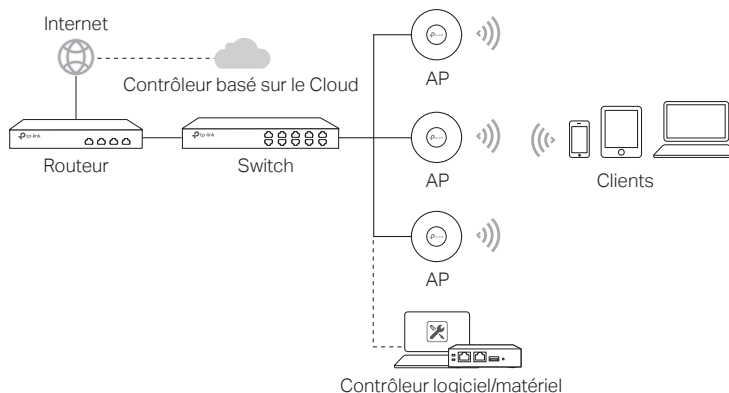

Certains points d'accès peuvent être configurés et surveillés de manière centralisée via un contrôleur. Pour plus de détails, veuillez vous référer aux spécifications du produit et au manuel du produit ou du contrôleur correspondant. Vous pouvez obtenir le contrôleur sur <https://www.tp-link.com> ou contacter l'équipe commerciale.

Installation matérielle

■ Option 1 : Montage au plafond

Suivre les étapes ci-après pour installer AP à l'aide des accessoires fournis :

Remarque : le support de montage et les accessoires (quantité et taille) peuvent varier selon le produit.



Rondelles



Vis CHC



Écrous papillon

1 Démontez la dalle du plafond

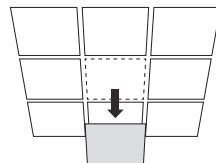

- 2 Placer le support de montage au centre de la dalle du plafond. Marquer les positions des trous de vis et une position pour le trou du câble Ethernet. Percer des trous pour les vis et un trou pour le câble Ethernet aux emplacements marqués.

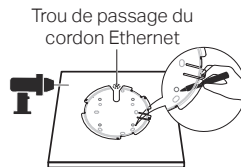

- 3 Fixer le support de montage au clip de fixation pour rails de plafond à l'aide des vis CHC.

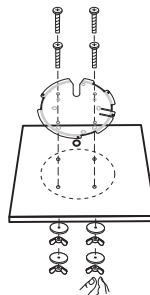

- 4 Passer le cordon Ethernet au travers du trou dédié et remettre la dalle de plafond à sa place.

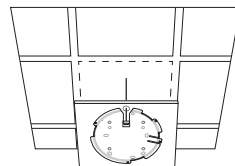

- 5 Connecter le cordon Ethernet au port Ethernet. Fixer AP au support de montage en alignant les flèches présentes sur AP avec celles du support de montage, par une rotation dans le sens des aiguilles d'une montre positionner AP jusqu'au dé clic de verrouillage.

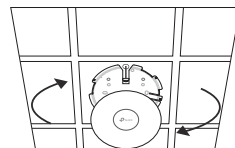

■ Option 2 : Montage en applique (mural)

Suivre les étapes ci-après pour installer AP à l'aide des accessoires fournis:

Remarque : le support de montage et les accessoires (quantité et taille) peuvent varier selon le produit.



Chevilles plastiques



Vis

- 1** Si votre câble Ethernet traverse le mur, positionnez le support de montage et faites passer le câble Ethernet. Marquez les positions des trous de vis, puis percez des trous aux positions marquées.

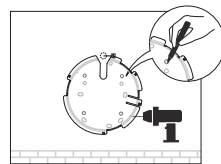

- 2** Insérer les chevilles dans les trous percés précédemment.

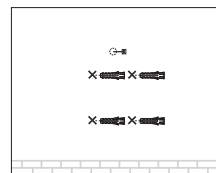

- 3** Fixer le support de montage en vissant les vis dans les chevilles. Assurez-vous que les saillies du support soient dirigées vers vous.

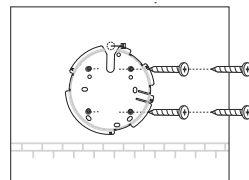

- 4** Connecter le cordon Ethernet au port Ethernet de l'AP.

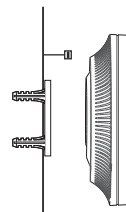

- 5** Fixer l'AP au support de montage en alignant les flèches sur l'AP avec celles sur le support de montage, par une rotation dans le sens des aiguilles d'une montre positionner l'AP jusqu'au dé clic de verrouillage.

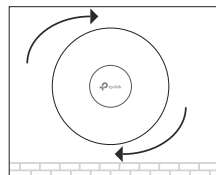

Alimentation

■ Alimentation PoE ou via un adaptateur secteur

Certains points d'accès peuvent être alimentés via l'adaptateur secteur ou le périphérique PSE (tel qu'un commutateur PoE) qui est conforme à la classe de source d'alimentation 2 (PS2) ou à la source d'alimentation limitée (LPS) de la norme CEI 62368-1.

Remarque : la disponibilité dépend du produit réel. Veuillez vous référer aux spécifications du produit.

Via un switch PoE

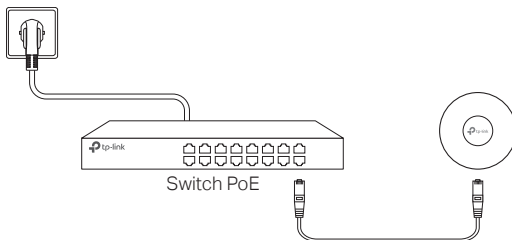

Via adaptateur secteur

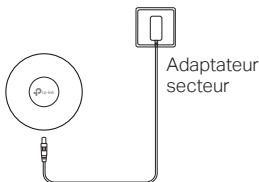

■ Alimenté via un injecteur PoE

Certains points d'accès peuvent être alimentés via l'adaptateur PoE.

Remarque : la disponibilité dépend du produit réel. Veuillez vous référer aux spécifications du produit.

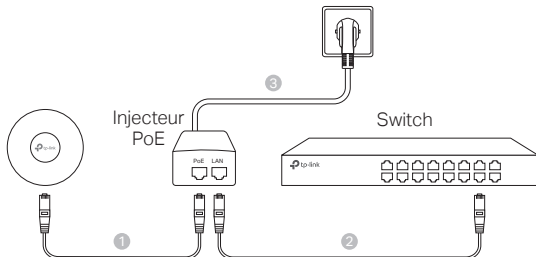

Aviso: A imagem pode diferir do produto real.

Topologia de Rede

Segue abaixo uma topologia de rede típica para o AP.

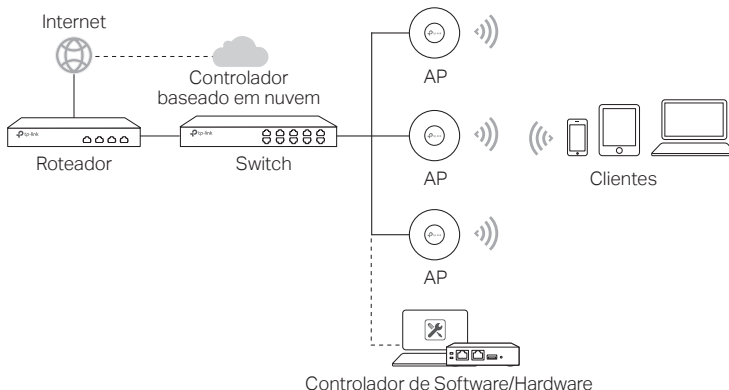

Alguns APs podem ser configurados e monitorados de forma centralizada por meio de um controlador. Para mais detalhes, consulte as especificações do produto e o manual do produto ou controlador correspondente. Você pode obter o controlador em <https://www.tp-link.com> ou entrar em contato com a equipe de vendas.

Instalação de Hardware

■ Opção 1: Montagem em Teto

Segue abaixo os passos para instalar o AP com os acessórios fornecidos:

Observação: O suporte de montagem e os acessórios (quantidade e tamanho) podem variar de acordo com o produto.



Arruelas



Parafuso cabeça chata



Porcas-borboleta

- 1 Remova o ladrilho do teto.

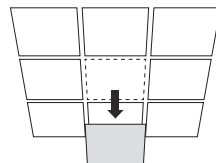

- 2** Coloque o suporte de montagem no centro do forro. Marque as posições para os orifícios dos parafusos e uma posição para o orifício do cabo Ethernet. Faça orifícios para os parafusos e um orifício para o cabo Ethernet nas posições marcadas.

Furo para cabo Ethernet

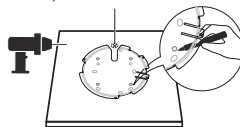

- 3** Fixe o suporte de montagem ao ladrilho do teto usando Parafuso cabeça chata, as arruelas e as porcas-borboleta.

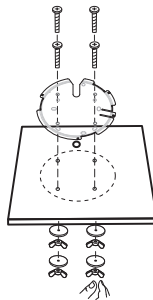

- 4** Passe o cabo Ethernet através do furo e coloque o ladrilho em seu lugar novamente.

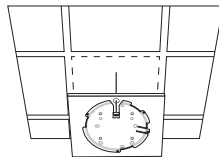

- 5** Conecte o cabo Ethernet à porta ETHERNET. Conecte o AP ao suporte de montagem alinhando a marca de seta no AP com a marca de seta no suporte de montagem e, em seguida, gire o AP até se encaixar no lugar, como mostrado à esquerda.

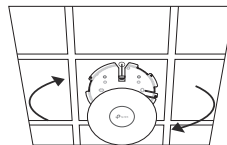

■ Opção 2: Montagem em Parede

Segue abaixo os passos para instalar o AP com os acessórios fornecidos:

Observação: O suporte de montagem e os acessórios (quantidade e tamanho) podem variar de acordo com o produto.



Buchas de Parede de Plástico



Parafusos Auto-roscantes

- 1** Se o cabo Ethernet passar pela parede, posicione o suporte de montagem e alimente o cabo Ethernet. Marque as posições dos orifícios dos parafusos e faça orifícios nas posições marcadas.

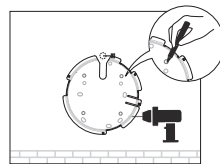

- 2** Insira as buchas de parede de plástico nos furos.

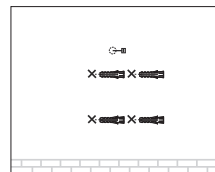

- 3** Fixe o suporte de montagem na parede, movendo os parafusos auto-roscentes nas buchas. Certifique-se de que os ombros do suporte de montagem estão no lado de fora.

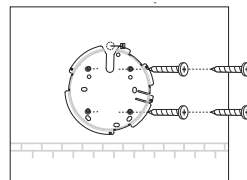

- 4** Conecte o cabo Ethernet à porta ETHERNET no AP.

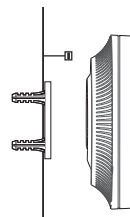

- 5** Conecte o AP ao suporte de montagem alinhando a marca de seta no AP com a marca de seta no suporte de montagem e, em seguida, gire o AP até encaixar no lugar.

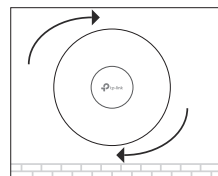

Fornecimento de Energia

■ Energia via Dispositivo PoE ou Fonte de Energia

Alguns APs podem ser alimentados por meio do adaptador de energia ou do dispositivo PSE (como um switch PoE) compatível com Power Source Class 2 (PS2) ou Limited Power Source (LPS) do IEC 62368-1.

Observação: A disponibilidade depende do produto real. Consulte as especificações do produto.

Via Switch PoE

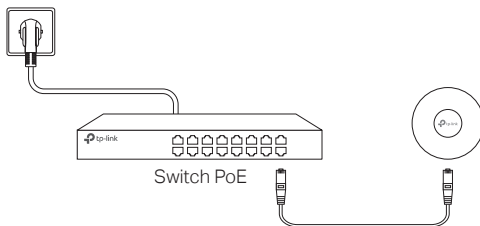

Via Fonte de Energia

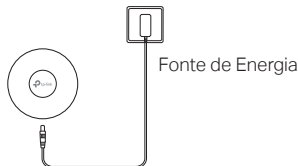

■ Energia via Adaptador PoE

Alguns APs podem ser alimentados por meio do adaptador PoE.

Observação: A disponibilidade depende do produto real. Consulte as especificações do produto.

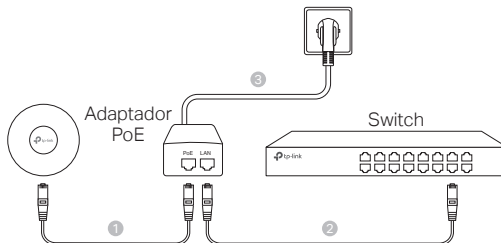

Para informações de aspectos de segurança e adequação do produto no território brasileiro consulte: www.gov.br/anatel/pt-br/



For technical support, the user guide and other information, please visit <https://www.tp-link.com/support/?type=smb>, or simply scan the QR code.