





KB Series
VIDEO DOOR STATION



Model: **KB-DAR**, *Single-gang surface mount*



INSTALLATION & OPERATION MANUAL



PRECAUTIONS ON INSTALLATION & WIRING

 **WARNING** *Negligence could result in death or serious injury.*

- When existing chime wires are used, be sure to locate and disconnect the bell transformer. 
Unit damage or electric shock could result. Ask qualified personnel.
- Do not change or alter KB-DAR. It can cause fire or electric shock. 
- Video door station is weather-resistant, but do not spray water directly on video door station to prevent electric shock. 
- Make sure wires are connected properly before plugging in power supply. Fire or electric shock could result. 

 **GENERAL PRECAUTIONS** –  mark indicates caution statement (incl. danger and warning), which is specifically shown inside.

 **GENERAL INSTRUCTIONS** –  mark indicates contents which demand a specific action shown inside or attached.

 **GENERAL PROHIBITIONS:** –  mark indicates contents which prohibit a specific action shown inside or attached.

 **DISMANTLE PROHIBITIONS**

Package Contents

- Video door station (**KB-DAR**)
- Packet of screws
- Hexagonal wrench
- Installation & Operation Manual

1 SYSTEM OUTLINE & COMPONENTS

KB-DAR is a video door station for use with KB-3MRD system. Up to three KB-DAR's can be connected to master station.

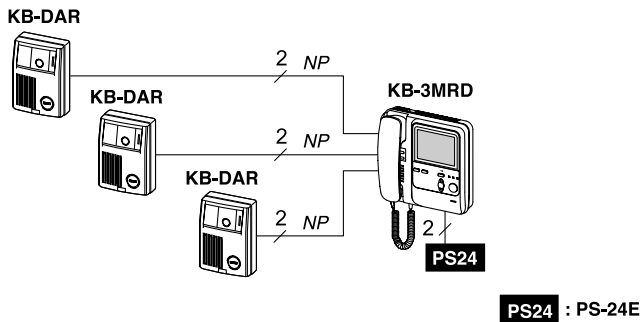

KB-DAR: Video door station.
KB-3MRD: Master station.

2 NAMES & FEATURES

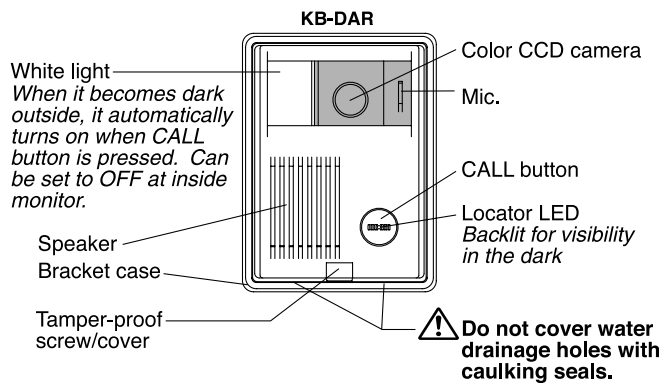

- Features**
- 2-conductor non-polarized wiring
 - White LED light auto turn on or off
 - Single-gang surface mounting

3 INSTALLATION

Wiring precautions

- Keep video wires more than 30cm/1' away from AC 100 ~ 240V power lines.
- Employ 2-conductor parallel wires only. Specify **PE (polyethylene) insulation, vinyl-sheathed**. Coax-cable cannot be used. For other types, normal operation or max. communication distance cannot be guaranteed.
- When existing cable is used, install a 120Ω resistor at both ends of unused wires.
- Do not mix audio/video wires with those of another video door station or device.

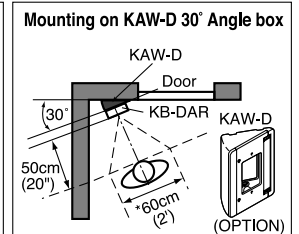
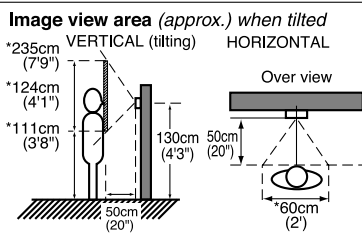
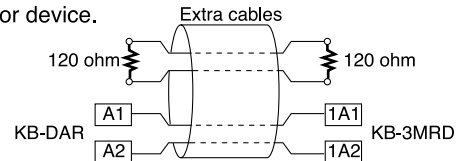

Mounting locations & height

- Do not install a video door station in the following locations;
- Places subject to temperature/humidity extremes.
 - Places near dust, vapor, smoke and chemicals.
 - Places where a call is strongly backlit (bright background).
 - Places where direct sunlight or strong light comes into the camera lens.

Mounting locations

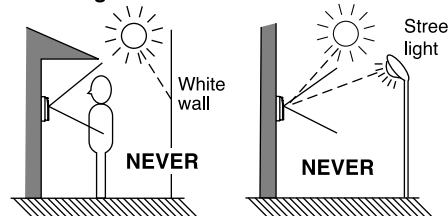

Mounting height

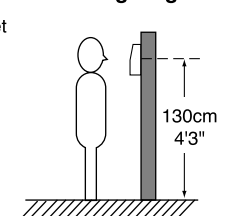

4 WIRING DIAGRAM

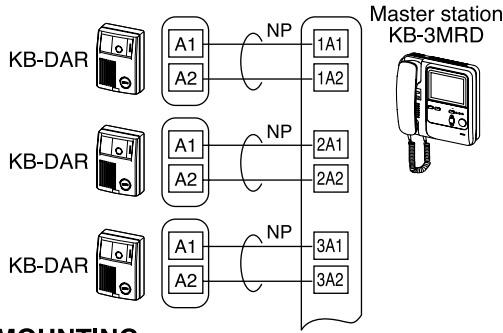

5 MOUNTING

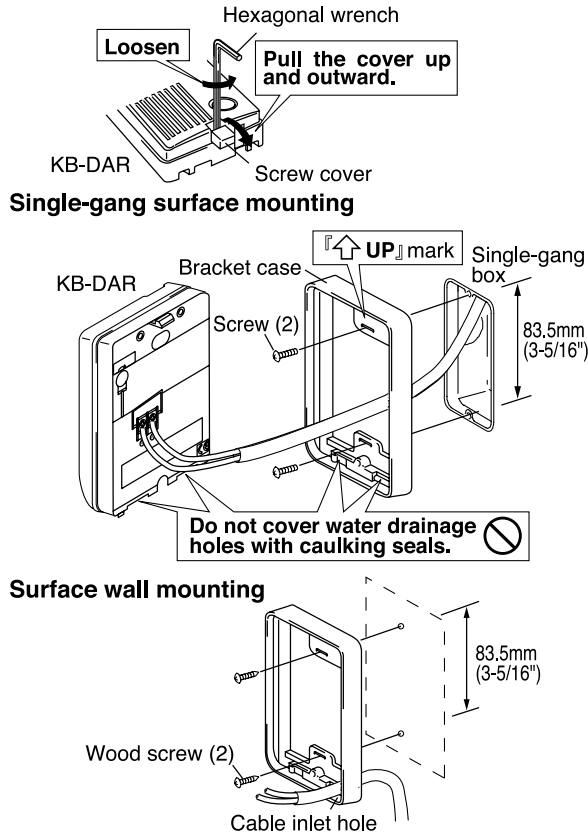

6 OPERATIONS

Calling

Momentarily press CALL button on video door station. After room station replies, talk hands free in front of camera.

Instant-On audio/video

After chime tone sounds, inside stations see image and hear audio of door without lifting handset.

7 TECHNICAL PRECAUTIONS

Caulking seals: Do not apply any caulking seals around video door station. Water drainage holes on bottom will help water or moisture to dissipate.

Cleaning: Clean KB-DAR with a soft cloth dampened with neutral household cleaner and cloth. Do not spray high-pressure water on video door station.

8 SPECIFICATIONS

Power source:	Max. 22V DC (approx.), supplied by master station. Standby 12V DC (approx.).
Current consumption:	Max. 260mA (approx.). Standby 5mA (approx.).
Communication:	Simultaneous in open voice.
Picture element:	1/4 inch color CCD.
Night viewing:	Up to 30cm (1') in front of camera. White LED light projects up to 30cm (1') away. Back ground scene over 30cm (1') can not be seen.
Ambient temperature:	- 10°C ~ 60°C (14°F ~ + 104°F).
Housing:	Fire-retardant ABS plastic.
Color:	Gray.
Dimensions:	105 W x 140H x 44 D (mm). 4-1/8"W x 5-1/2"H x 1-3/4"D.
Weight:	300g (0.66 lbs.) approx.

This equipment has been tested and found to comply with the limits for a Class B digital device, pursuant to Part 15 of the FCC Rules. These limits are designed to provide reasonable protection against harmful interference in a residential installation. This equipment generates, uses, and can radiate radio frequency energy, and if not installed and used in accordance with the instructions, may cause harmful interference to radio communications. However, there is no guarantee that interference will not occur in a particular installation. If this equipment does cause harmful interference to radio or television reception, which can be determined by turning the equipment off and on, the user is encouraged to try to correct the interference by one or more of the following measures:

- Reorient or relocate the receiving antenna.
- Connect the equipment into an outlet on a circuit different from that to which the receiver is connected.
- Increase the separation between the equipment and receiver.
- Consult the dealer or an experienced radio/TV technician for help.

WARRANTY

Aiphone warrants its products to be free from defects of material and workmanship under normal use and service for a period of two years after delivery to the ultimate user and will repair free of charge or replace at no charge, should it become defective upon which examination shall disclose to be defective and under warranty. Aiphone reserves unto itself the sole right to make the final decision whether there is a defect in materials and/or workmanship; and whether or not the product is within the warranty.

This warranty shall not apply to any Aiphone product which has been subject to misuse, neglect, accident, or to use in violation of instructions furnished, nor extended to units which have been repaired or altered outside of the factory.

This warranty does not cover batteries or damage caused by batteries used in connection with the unit.

This warranty covers bench repairs only, and any repairs must be made at the shop or place designated in writing by Aiphone. Aiphone will not be responsible for any costs incurred involving on site service calls.

AIPHONE CO., LTD., NAGOYA, JAPAN
AIPHONE CORPORATION, BELLEVUE, WA, USA
AIPHONE EUROPE N.V., ANTWERP, BELGIUM

COMMUNICATION SYSTEMS
AIPHONE[®]
HOME, BUSINESS, INDUSTRY.

KB-DAR-I(E) 0200A