

ENFORCER®

Request-to-Exit Plate with Pneumatic Timer

Installation Manual



SD-7213-GSP shown



Intertek
5024193
Conforms to
UL Std. 294

Pneumatic
Timer

No
Power
Required

| Model | Faceplate | Message | Pushbutton |
|-------------|-------------------|---------------|--------------------|
| SD-7113-GSP | Slimline plate | Exit / Salida | Green mushroom |
| SD-7113-RSP | Slimline plate | Exit / Salida | Red mushroom |
| SD-7183-GSP | Slimline plate | Push to Exit | Green mushroom |
| SD-7213-GSP | Single-gang plate | Exit / Salida | Green mushroom |
| SD-7213-RSP | Single-gang plate | Exit / Salida | Red mushroom |
| SD-7283-RSP | Single-gang plate | Push to Exit | Large red mushroom |

The ENFORCER SD-7xx3-xSP series Request-to-Exit Plates with Pneumatic Timer are ideal when providing power to a timer is inconvenient, hazardous, or not conforming with local ordinances and codes. Adjusting the time is easy via a timing screw and can be performed on the spot without tools.

- Conforms to NFPA 101 Fire Codes for non-electrical breaking of contact
- Functions entirely without electricity
- Excellent for installations where supplying additional timer power is inconvenient
- Reliable US-made pneumatic components
- Stainless steel single-gang faceplate
- English and Spanish printed on the faceplate (except SD-7183-GSP, SD-7283-RSP)
- Timer adjustable for 1~60 seconds

Parts List

1x Request-to-exit plate

2x Faceplate screws

1x Manual

Specifications

| Model | SD-7113-GSP | SD-7113-RSP | SD-7183-GSP | SD-7213-GSP | SD-7213-RSP | SD-7283-RSP |
|--------------------------|--|-------------|-------------|--------------------------------------|-------------|-------------|
| Faceplate | Slimline, brushed stainless steel | | | Single-gang, brushed stainless steel | | |
| Mushroom cap button | Standard | | | | | Large |
| Size | | | | | | |
| Color | Green | Red | Green | | Red | |
| Timer | Pneumatic: 1-60 seconds* | | | | | |
| Switching capacity | 5A@125VAC | | | | | |
| Wiring | 2x N.C. #18 AWG 9" (230mm) for fail-safe | | | | | |
| Red | | | | | | |
| White | 2x N.O. #18 AWG 9" (230mm) for fail-secure | | | | | |
| Destructive attack level | Level I | | | | | |
| Line security | Level I | | | | | |
| Endurance level | Level I | | | | | |
| Standby power | Level I | | | | | |
| Operating temperature | 32°~131° F (0°~55° C) | | | | | |
| Dimensions | 1½"x4½"x3½" (38x115x88 mm) | | | 2¾"x4½"x3½" (70x115x88 mm) | | |

* Note: Time is precise to within ±10% for constant temperature and may vary according to environmental factors.

Overview

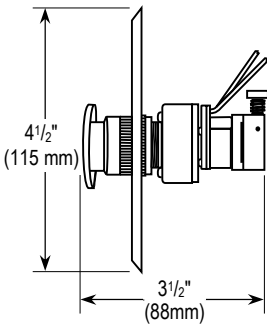

SD-7113-xSP



SD-7183-GSP

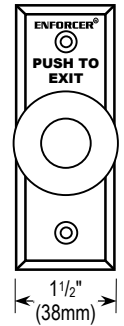

SD-7213-xSP

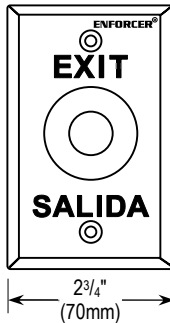

SD-7283-RSP

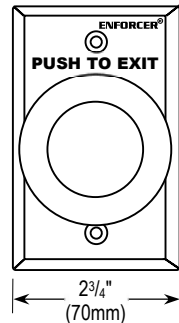

Installation

1. Find a suitable location for the pneumatic request-to-exit plate.
2. The pneumatic request-to-exit plate can be either surface mounted or flush mounted.
3. Wire the request-to-exit plate as described below in *Wiring*.
4. Adjust the timer as described below in *Adjusting the Timer*.
5. Test the function of the exit plate and timer, as well as the timer delay.

Wiring

1. For N.C. operation (fail-safe), connect the red wires to the electronic lock or other device.
2. For N.O. operation (fail-secure), connect the white wires to the electronic lock or other device.

NOTE: Use only low-voltage, power-limited/Class 2 power supply and low-voltage field wiring not to exceed 98.5ft (30m).

Adjusting the Timer

1. Locate the timing screw as shown in the figure to the right.
 2. Gently rotate the timing screw to:
 - a. To increase the delay, turn the screw clockwise.
 - b. To decrease the delay, turn the screw counterclockwise.
- NOTE:** Do not overtighten or over-loosen the timing screw. If the screw becomes very loose, retighten it until it feels secure.
3. The minimum delay time is approximately 1 second, and the maximum delay time is approximately 60 seconds. Use a stopwatch to adjust the time to suit the application.

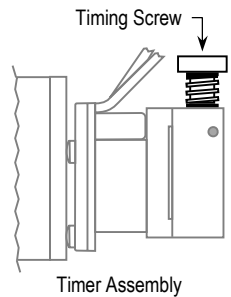

Sample Applications

Installation with a Maglock and Access Control System

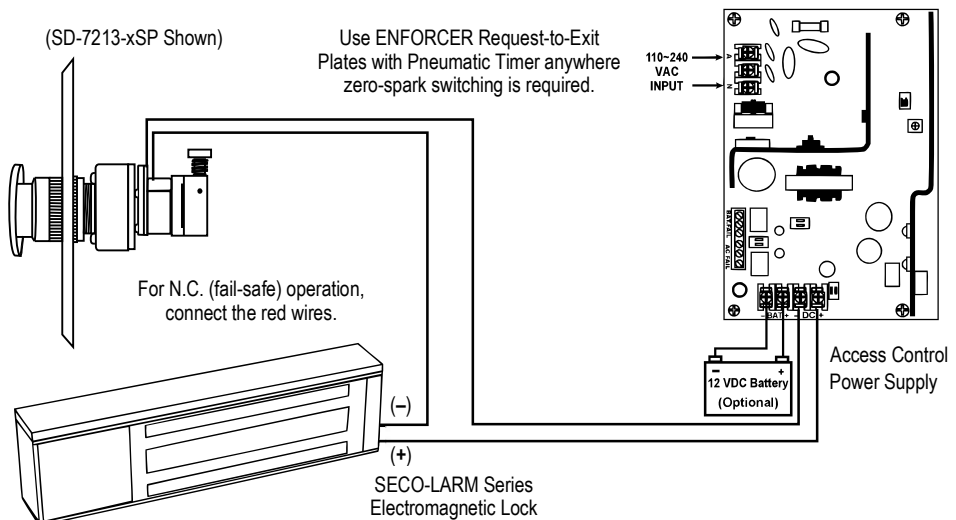

Sample Applications (Continued)

Installation with a Maglock and an Access Control Keypad

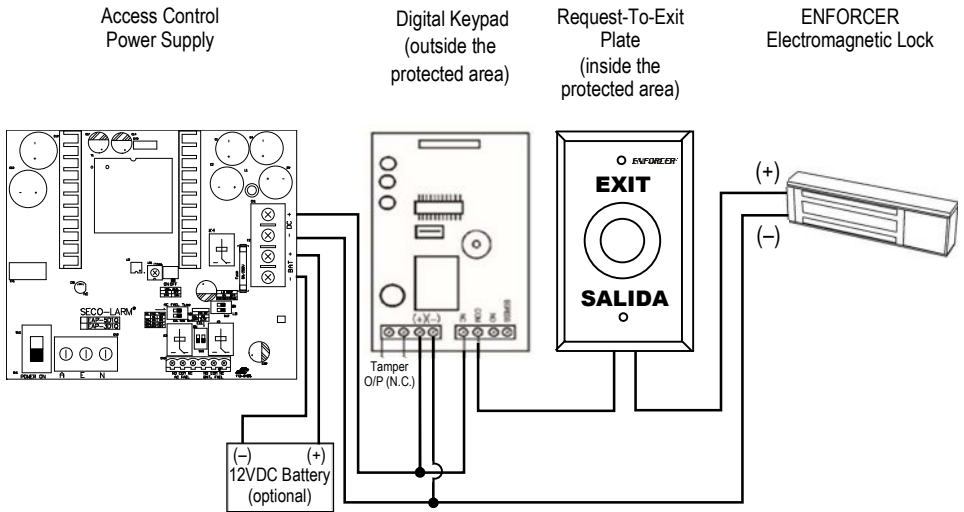

IMPORTANT WARNING: Incorrect mounting which leads to exposure to rain or moisture inside the enclosure could cause a dangerous electric shock, damage the device, and void the warranty. Users and installers are responsible for ensuring that this product is properly installed and sealed

IMPORTANT: Users and installers of this product are responsible for ensuring that the installation and configuration of this product complies with all national, state, and local laws and codes. SECO-LARM will not be held responsible for the use of this product in violation of any current laws or codes.

California Proposition 65 Warning: These products may contain chemicals which are known to the State of California to cause cancer and birth defects or other reproductive harm. For more information, go to www.P65Warnings.ca.gov.

WARRANTY: This SECO-LARM product is warranted against defects in material and workmanship while used in normal service for one (1) year from the date of sale to the original customer. SECO-LARM's obligation is limited to the repair or replacement of any defective part if the unit is returned, transportation prepaid, to SECO-LARM. This Warranty is void if damage is caused by or attributed to acts of God, physical or electrical misuse or abuse, neglect, repair or alteration, improper or abnormal usage, or faulty installation, or if for any other reason SECO-LARM determines that such equipment is not operating properly as a result of causes other than defects in material and workmanship. The sole obligation of SECO-LARM and the purchaser's exclusive remedy, shall be limited to the replacement or repair only, at SECO-LARM's option. In no event shall SECO-LARM be liable for any special, collateral, incidental, or consequential personal or property damage of any kind to the purchaser or anyone else.

NOTICE: The SECO-LARM policy is one of continual development and improvement. For that reason, SECO-LARM reserves the right to change specifications without notice. SECO-LARM is also not responsible for misprints. All trademarks are the property of SECO-LARM U.S.A., Inc. or their respective owners. Copyright © 2023 SECO-LARM U.S.A., Inc. All rights reserved.

SECO-LARM® U.S.A., Inc.

16842 Millikan Avenue, Irvine, CA 92606
Phone: (949) 261-2999 | (800) 662-0800

Website: www.seco-larm.com
Email: sales@seco-larm.com

 PITSW1
Order Part# 763-172-6*
ML_SD-7xx3-xSP_220909.docx