

Wave-to-Open Sensor

SD-927PKC-NEQ English*, No-Touch

SD-927PKC-NEVQ English*, No-Touch, Override Button



The ENFORCER Wave-to-Open Sensor uses IR technology to allow egress from a protected area or activate a device with just a wave of a hand. Since no touch is required, this sensor is suitable for use in hospitals, clinics, labs, clean rooms (to reduce the risk of contamination), schools, factories, or offices. The SD-927PKC-NEVQ adds a manual override button.

Features:

- Operating voltage, 12~24 VAC/VDC
- Range adjustable from 2³/₈"~8" (6~20 cm)
- Stainless steel single-gang faceplate
- 3A relay, adjustable from 0.5~30 sec, toggle, or as long as hand is near the sensor
- Quick connect screwless terminal block
- LED illuminated sensor area for easy identification
- Selectable LED colors (turns from red to green or green to red when activated)

SD-927PKC-NEVQ

- Adds manual override button as a backup to the sensor

Specifications:

Model	SD-927PKC-NEQ	SD-927PKC-NEVQ
Operating voltage	12~24 VAC/VDC	
Current draw (max.)	120mA@12VDC	
Relay type	Form C dry contact NO/NC/COM, 3A@24VDC	
Override button	Switching capacity	N/A
	Mechanical life	N/A
		3A@24VDC
		500,000 Cycles
Response time	10ms	
LEDS	Standby	Red†
	Triggered	Green†
Output time	Adjustable, 0.5~30sec., toggle, or as long as sensor is triggered	
Sensing range	Adjustable, 2 ³ / ₈ "~8" (6-20 cm)	
Operating temperature	-4°~131° F (-20°~55° C)	
Dimensions	2 ³ / ₄ "x4 ¹ / ₂ "x1 ¹ / ₈ " (70x114x28 mm)	
Weight	3-oz (85g)	3.9-oz (110g)

*French (SD-927PKC-NFQ, SD-927PKC-NFVQ) and Spanish (SD-927PKC-NSQ, SD-927PKC-NSVQ) faceplates also available.

†Reversible by jumper



SD-927PKC-NEQ

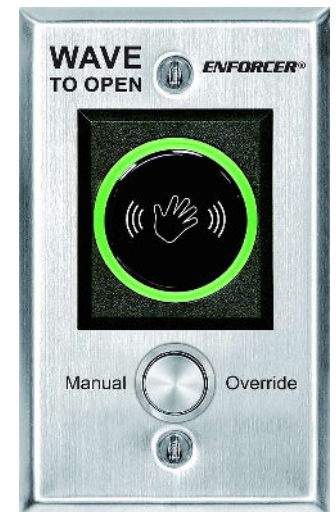

SD-927PKC-NEVQ



Dimensions:

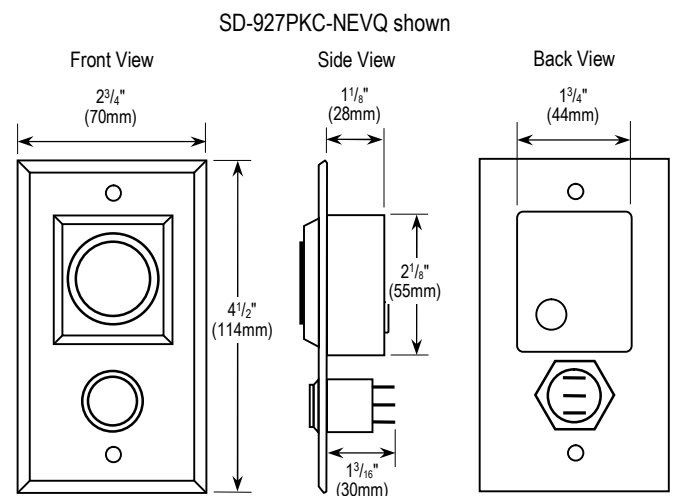

SECO-LARM® U.S.A., Inc.

16842 Millikan Avenue, Irvine, CA 92606

Phone: (949) 261-2999 | (800) 662-0800 Fax: (949) 261-7326

Website: www.seco-larm.com Email: sales@seco-larm.com







Copyright © 2023 SECO-LARM U.S.A., Inc. All rights reserved. All trademarks are the property of SECO-LARM U.S.A., Inc. or their respective owners. The SECO-LARM policy is one of continual development. For that reason, SECO-LARM reserves the right to change prices and specifications without notice. SECO-LARM is not responsible for misprints.



SECO-LARM® ENFORCER® CRIMEBUSTER® CBA® SLI®

PI_SD-927PKC-NEQ_230718.docx

Ordering Information:

Wave-to-Open Sensors				
Model	SD-927PKC-NEQ	SD-927PKC-NFQ	SD-927PKC-NSQ	SD-927PWCQ*
Language	English	French	Spanish	English, French, and Spanish Decals
Photo				

Wave-to-Open Sensors with Override Button			
Model	SD-927PKC-NEVQ	SD-927PKC-NFVQ	SD-927PKC-NSVQ
Language	English	French	Spanish
Photo			

Sensor Only			
Model	CS-PD535-TAQ	CS-PD535-TBQ†	<p>For our full line of OEM/private label infrared sensors, contact SECO-LARM</p>
Photo			
Description	1 1/4" (32mm) Sensor	1 1/4" (32mm) Sensor	

*For SD-927PWCQ specifications, visit www.seco-larm.com

†Special order. Contact SECO-LARM for details

SECO-LARM® U.S.A., Inc.

16842 Millikan Avenue, Irvine, CA 92606

Phone: (949) 261-2999 | (800) 662-0800 Fax: (949) 261-7326

Website: www.seco-larm.com Email: sales@seco-larm.com



Copyright © 2023 SECO-LARM U.S.A., Inc. All rights reserved. All trademarks are the property of SECO-LARM U.S.A., Inc. or their respective owners. The SECO-LARM policy is one of continual development. For that reason, SECO-LARM reserves the right to change prices and specifications without notice. SECO-LARM is not responsible for misprints.

SECO-LARM® ENFORCER® CRIMEBUSTER® CBA® SLI®