

Post-Mount Wave-to-Open Sensor with Access Box



SD-9963-KSGQ Manual Override

The ENFORCER Post-Mount Wave-to-Open Sensor with Access Box and Manual Override Button is a full-featured exit plate which uses IR technology to open a gate or activate a device with the simple wave of a hand reducing the risk of the spread of disease. It is suitable for areas where no special clearance is required for exit and a longer-range sensor may cause unwanted activation. It also includes a manual override button.

Features

- Adjustable sensor range up to 7" (18cm)
- Weather resistant for outdoor use
- Stainless steel plate
- Hinged plate easily removes from box for easy wiring
- 1A Relay, adjustable trigger duration 0.5~30 seconds or toggle
- Gooseneck- or wall-mountable
- Manual override button
- LED-illuminated sensor area for easy identification
- Selectable LED colors (turns from red to green or green to red on sensor activation)
- Includes heavy-duty steel box



Specifications

Operating voltage	12~24 VDC	
Current	Standby	16mA@12VDC / 25mA@24VDC
	Triggered	25mA@12VDC / 32mA@24VDC
Relay type	Form C dry contact, 1A@30VDC	
Response time	10mS	
LEDs	Standby	Red*
	Triggered	Green*
Output time	0.5~30 s or toggle	
Range	2"~7" (5~18 cm)	
IP Rating	IP65†	
Temperature range	-4°~131° F (-20°~55° C)	
Weight	1-lb 9-oz (710g)	
Size	4"x5½"x3" (102x134x77mm)	

*Color function reversible

†Front panel only

Sample Installation

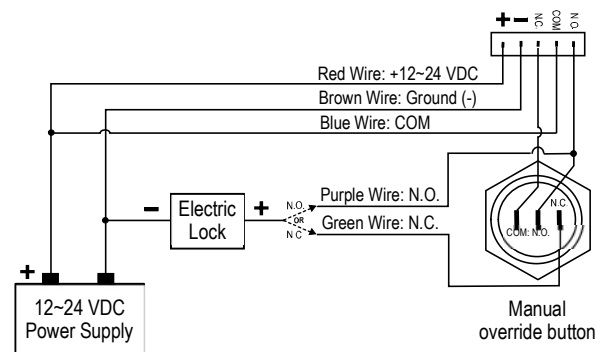

Override button is prewired from the factory.
No further wiring necessary

SECO-LARM® U.S.A., Inc.

16842 Millikan Avenue, Irvine, CA 92606

Phone: (949) 261-2999 | (800) 662-0800 Fax: (949) 261-7326

Website: www.seco-larm.com Email: sales@seco-larm.com









Copyright © 2022 SECO-LARM U.S.A., Inc. All rights reserved.
All trademarks are the property of SECO-LARM U.S.A., Inc. or their respective owners.
The SECO-LARM policy is one of continual development. For that reason, SECO-LARM reserves the right to change prices and specifications without notice. SECO-LARM is not responsible for misprints.



SECO-LARM® ENFORCER® CRIMEBUSTER® CBA® SLI®

PI_SD-9963-KSGQ_220826.docx



Ordering Information

Outdoor Wave-to-Open Sensors*						
Model	SD-9163-KSQ	SD-9263-KSQ	SD-9163-KS1Q	SD-9263-KS1Q	SD-9163-KS2Q	SD-9263-KS2Q
Language	English		Spanish		French	
Photo						

*Also available with European faceplate in English, Spanish, and French models

Outdoor Wave-to-Open Sensors with Override Button			
Model	SD-9163-KSVQ	SD-9263-KSVQ	SD-9463-KSVQ
Language	English†		
Photo			

†Spanish and French faceplates available by special order

Outdoor Wave-to-Open Sensors – Other Models			
Model	SD-9963-KSGQ	SD-9773-KNEVQ	
Type	Post-Mount	Surface-Mount	
Photo			<p>Other Models Also Available. For our full line of OEM/private label infrared sensors, contact SECO-LARM</p>

SECO-LARM® U.S.A., Inc.

16842 Millikan Avenue, Irvine, CA 92606

Phone: (949) 261-2999 | (800) 662-0800 Fax: (949) 261-7326

Website: www.seco-larm.com Email: sales@seco-larm.com



Copyright © 2022 SECO-LARM U.S.A., Inc. All rights reserved. All trademarks are the property of SECO-LARM U.S.A., Inc. or their respective owners. The SECO-LARM policy is one of continual development. For that reason, SECO-LARM reserves the right to change prices and specifications without notice. SECO-LARM is not responsible for misprints.

SECO-LARM® ENFORCER® CRIMEBUSTER® CBA® SLI®