

GENTEX CORPORATION

A Smarter Vision®

VISIBLE AND/OR AUDIBLE SIGNALING APPLIANCES

GEC24, GES24, GEH24 & GEH12 SERIES
GEC3-24, GEC3-12, GES3-24 & GES3-12 SERIES

ANSI/UL 1971 and/or ANSI/UL 464 COMPLIANT

ANSI/UL 1638 and/or ANSI/UL 464 COMPLIANT

WGEC24 & WGES24 SERIES

GECA24, GESA24, GECB24, GESB24, GECG24, GECG24, GECR24, GESR24 & GESR24 SERIES

GECG24, GECR24 & GESR24 SERIES

WGEC24, WGES24, WGECB24, WGESB24, WGECG24, WGESG24, WGECR24 & WGESR24 SERIES

WGECG24, WGESG24, WGECR24 & WGESR24 SERIES

ANSI/UL 1638 AND/OR ANSI/UL 464 COMPLIANT

SIGNALING



I. INTRODUCTION

The Gentex models GEC24, GES24, GEH24, GEH12, GEC3-24, GES3-24, GEC3-12, GES3-12, WGEC24, WGES24, GECA24, GESA24, GECB24, GESB24, GECG24, GECG24, GECR24, GESR24, WGEC24, WGES24, WGECB24, WGESB24, WGECG24, WGESG24, WGECR24, WGESR24 are high quality audible and/or visible signaling appliances. The high intensity strobe utilizes a Xenon flash tube that generates a high-intensity flash visible from all angles. This appliance is intended to provide a visible, audible or audible/visible, depending on the model, notification signal for the purpose of life safety and property protection. The GEC3-24, GES3-24, GEC3-12, GES3-12, GECA24, GESA24, GECB24, GESB24, GECG24, GECG24, GECR24, GESR24 are provided with a slider switch which allows for candela selection at the installation site; the candela intensities which can be selected are 15Cd, 30Cd, 60Cd, 75Cd, or 110Cd (24VDC only). The GEC24 and GES24 are fixed candela units; the candela intensities which can be ordered, are 177Cd and 15/75Cd. The WGEC24, WGES24, WGEC24, WGES24, WGECB24, WGESB24, WGECG24, WGESG24, WGECR24, WGESR24 are fixed candela units, available in a 75 candela intensity only. This appliance is ideal for any occupancy that requires notification appliances per the applicable building or fire code or wherever dependable alarms are required.

The GEC24, GES24, GEC3-24, GES3-24, GEC3-12, GES3-12 strobe is listed in compliance with ANSI/UL 1971, Signaling Appliances for the Hearing Impaired (the 15/75Cd model on the GEC24 and GES24 is additionally listed in compliance with ANSI/UL 1638). The WGEC24, WGES24, GECA24, GESA24, GECB24, GESB24, GECG24, GECG24, GECR24, GESR24, WGEC24, WGES24, WGECB24, WGESB24, WGECG24, WGESG24, WGECR24, WGESR24 strobe is listed in compliance with ANSI/UL 1638, Visual Signaling Appliances - Private Mode Emergency and General Signaling. Additionally, colored lens models GECA24, GESA24, GECB24, GESB24, GECG24, GECG24, GECR24, GESR24 comply with the polar dispersion requirements of ANSI/UL 1971.

II. LOCATION

This appliance is intended for use in Fire Alarm Systems and is to be installed in accordance with this manual, the recommendation of the local authorities having jurisdiction, and other NFPA documents that provide standards on notification appliances for protective signaling systems. The GEC24, GES24, GEH24, GEH12, GEC3-24, GES3-24, GEC3-12, GES3-12, GECA24, GESA24, GECB24, GESB24, GECG24, GECG24, GECR24, GESR24 are intended for indoor installations only; this appliance is **not** listed for **outdoor** or drip proof applications. The WGEC24, WGES24, WGEC24, WGES24, WGECB24, WGESB24, WGECG24, WGESG24, WGECR24, WGESR24 are intended for indoor or outdoor installations; this appliance is rated for outdoor or drip proof applications when used in conjunction with the GOE or GOELP Enclosure.

Wall mounted strobe and horn/strobe appliances shall have their entire lens at heights above the finished floor of not less than 80 in. (2m) and not greater than 96 in. (2.4m)**. Spacing shall be in accordance with Table A. If a room configuration is not square, the room size that will entirely encompass the room or subdivide the room into multiple squares shall be used. Wall mounted horn only appliances shall have their tops above the finished floors at heights of not less than 90 in. (2.30m) and below the finished ceilings at heights of not less than 6 in. (152mm). Different mounting heights shall be permitted by the AHJ provided the sound pressure level requirements of NFPA 72 are met.

III. MOUNTING, ROUGH-IN BOX AND RUN WIRING

This unit is designed for mounting to most single gang boxes, 4" square outlet boxes, 2-gang masonry boxes or non-metallic 2-gang switch boxes. Conduit entrance to boxes should be selected to insure sufficient wiring clearance.

1. Run a minimum 18 gauge insulated 2 or more conductor cable.
2. Mount a box for each remote signaling appliance. Screw bracket onto box. Insert signal into bracket and slide to the right firmly into the terminal block receptacle. Place housing over mounted assembly and screw together with single screw at the bottom of the signal. Cover screw with plastic tab.

NOTICE: WIRING SHOULD BE CONNECTED TO MOUNTING BRACKET PRIOR TO MOUNTING SIGNAL. INCOMING POSITIVE POWER LEAD MUST BE BROKEN AND EACH LEAD IS TO BE INSERTED INTO EACH OF THE TOP TWO TERMINALS. IF TWO POWER RUNS ARE MADE TO THE SIGNAL, ONE FOR THE STROBE AND ONE FOR THE HORN, ONLY ONE OF THE RUNS MUST HAVE ITS POSITIVE LEAD BROKEN AND PLACED UNDER THE TWO SEPARATE TOP TERMINALS. A BARRIER IS PROVIDED TO PREVENT BOTH LEADS FROM BEING PLACED UNDER THE SAME TERMINAL.

GEC24, GES24, GEC3-24, GES3-24, GEC3-12, GES3-12 PRODUCT INFORMATION

Table A Room Spacing for Wall-Mounted Visible Appliances per NFPA 72, 2010 Edition

Maximum Room Size		Minimum Required Light Output (Effective Intensity, Cd)		
Meters	Feet	One Light per Room	Two Lights per Room (Located on Opposite Walls)	Four Lights per Room (One Light per Wall)
6.10 x 6.10	20 x 20	15	NA	NA
8.53 x 8.53	28 x 28	30	Unknown	NA
9.14 x 9.14	30 x 30	34	15	NA
12.2 x 12.2	40 x 40	60	30	15
13.7 x 13.7	45 x 45	75	Unknown	19
15.2 x 15.2	50 x 50	94	60	30
16.5 x 16.5	54 x 54	110	Unknown	30
16.8 x 16.8	55 x 55	115	Unknown	28
18.3 x 18.3	60 x 60	135	95	30
19.2 x 19.2	63 x 63	150	Unknown	37
20.7 x 20.7	68 x 68	177	Unknown	43
21.3 x 21.3	70 x 70	184	95	60
24.4 x 24.4	80 x 80	240	135	60
27.4 x 27.4	90 x 90	304	185	95
30.5 x 30.5	100 x 100	375	240	95
33.5 x 33.5	110 x 110	455	240	135
36.6 x 36.6	120 x 120	540	305	135
39.6 x 39.6	130 x 130	635	375	185

NA = Not allowable

LIGHT OUTPUT IN PERCENTAGE WHEN MEASURED FROM THE FOLLOWING DIRECTIONS - PER UL1971

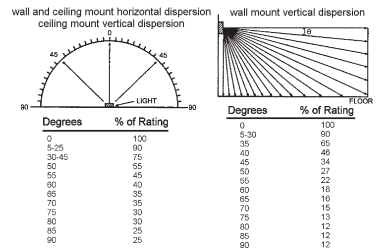

**Effective Intensity Requirements for Sleeping Areas

Visible Notification Appliance	
Distance from Ceiling to Top of Lens	Intensity
greater than or equal to 24"	110Cd
less than 24"	177Cd

CAUTION: Strobe light must be installed within 16 feet of the pillow when used in a sleeping area.

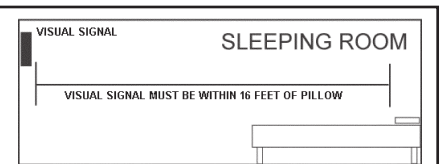

WARNING Strobe light can not be seen when objects such as doors, furniture or walls block strobe light.

NOTICE:

- THE VISUAL SIGNAL MUST BE IN THE DIRECT VIEWING AREA OF THE OCCUPANT IN ORDER TO BE SEEN.
- VISUAL SIGNALS FOR THE HEARING IMPAIRED ARE ONLY ONE METHOD OF ALERTING THE HEARING IMPAIRED. VISUAL SIGNALS MAY NOT BE THE PREFERRED METHOD FOR NOTIFYING ALL HEARING IMPAIRED INDIVIDUALS.
- THE STROBE LIGHT MUST BE SEEN BY THE SLEEPING PERSON. IF THE PERSON HAS HEAD TURNED OR OTHERWISE UNABLE TO BE ALERTED BY VISUAL, THE STROBE WILL NOT BE EFFECTIVE.

24VDC CLEAR Lens Indoor Strobe Current Ratings				
GEC24 and GES24 Series Available Candela	GEC3-24 and GES3-24 Series Available Candela	Strobe Candela	Regulated 24VDC Max. Operating Current(mA)	Regulated 24VFWR Max. Operating Current (mA) ¹
◆	◆	15	42	77
		15/75	67	113
	◆	30	58	102
	◆	60	97	161
	◆	75	116	225
	◆	110	161	256
◆		177	213	341

12VDC CLEAR Lens Strobe Current Ratings		
Use with GEC3-12 and GES3-12 Products		
Candela	Regulated 12VDC Max. Operating Current (mA)	Regulated 12VFWR Max. Operating Current (mA) ¹
15	92	145
30	141	224
60	260	459
75	312	460

NOTICE: DC VOLTAGE RANGE LIMITS: 16-33V. FWR VOLTAGE RANGE LIMITS: 16-33V. THIS PRODUCT WAS ONLY TESTED TO THE STATED VOLTAGE RANGE(S); DO NOT APPLY 80% AND 110% OF THIS RANGE FOR SYSTEM OPERATION.

¹ When using products manufactured after 7-1-10, these values are to be used when calculating current draws.

WGEC24, WGES24, WGECA24, WGESA24, WGECB24, WGESB24, WGECEG24, WGESG24, WGECECR24, WGESER24 PRODUCT INFORMATION

LIGHT OUTPUT IN PERCENTAGE WHEN MEASURED FROM THE FOLLOWING DIRECTIONS - PER UL1638

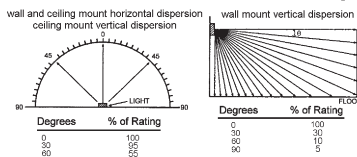

Models	Color Lens
WGECA24, WGESA24	Amber
WGECB24, WGESB24	Blue
WGECEG24, WGESG24	Green
WGECECR24, WGESER24	Red

24VDC BLUE, GREEN & RED Lens Outdoor Strobe Current Ratings		
Use with WGECB24, WGESB24, WGECEG24, WGESG24, WGECECR24, WGESER24 Products		
Candela	Regulated 24VDC Max. Operating Current (mA)	Regulated 24VFWR Max. Operating Current (mA) ¹
75	164	278

24VDC CLEAR & AMBER Lens Outdoor Strobe Current Ratings		
Use with WGECEG24, WGES24, WGECA24, WGESA24 Products		
Candela	Regulated 24VDC Max. Operating Current (mA)	Regulated 24VFWR Max. Operating Current (mA) ¹
75	170	263

NOTICE: DC VOLTAGE RANGE LIMITS: 16-33V. FWR VOLTAGE RANGE LIMITS: 16-33V. THIS PRODUCT WAS ONLY TESTED TO THE STATED VOLTAGE RANGE(S); DO NOT APPLY 80% AND 110% OF THIS RANGE FOR SYSTEM OPERATION.

¹ When using products manufactured after 7-1-10, these values are to be used when calculating current draws.

GECA24, GESA24, GECB24, GESB24, GECEG24, GESG24, GECECR24, GESER24 PRODUCT INFORMATION

LIGHT OUTPUT IN PERCENTAGE WHEN MEASURED FROM THE FOLLOWING DIRECTIONS - PER UL1971

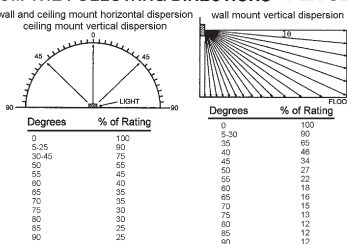

Models	Color Lens
GECA24, GESA24	Amber
GECB24, GESB24	Blue
GECEG24, GESG24	Green
GECECR24, GESER24	Red

AMBER Lens Indoor Strobe Current Ratings		
Use with GECA24 and GESA24 Products		
Candela	Regulated 24VDC Max. Operating Current (mA)	Regulated 24VFWR Max. Operating Current (mA) ¹
15	47	82
30	64	112
60	113	178
75	145	213
110	178	259

BLUE, GREEN & RED Lens Indoor Strobe Current Ratings		
Use with GECB24, GESB24, GECEG24, GESG24, GECECR24, GESER24 Products		
Candela	Regulated 24VDC Max. Operating Current (mA)	Regulated 24VFWR Max. Operating Current (mA) ¹
15	105	164
30	130	196
60	203	325
75	243	355
110	310	491

NOTICE: DC VOLTAGE RANGE LIMITS: 16-33V. FWR VOLTAGE RANGE LIMITS: 16-33V. THIS PRODUCT WAS ONLY TESTED TO THE STATED VOLTAGE RANGE(S); DO NOT APPLY 80% AND 110% OF THIS RANGE FOR SYSTEM OPERATION.

¹ When using products manufactured after 7-1-10, these values are to be used when calculating current draws.

HORN DECIBEL AND CURRENT RATINGS PRODUCT INFORMATION

Horn Mode	Horn Decibel Levels		Horn Current Ratings Over Input Voltage Range of 16-33V		Horn Mode	Horn Decibel Levels		Horn Current Ratings Over Input Voltage Range of 8-17.5V	
	Minimum SPL at 10Ft. Per ANSI/UL 464 (HIGH)	Minimum SPL at 10Ft. Per ANSI/UL 464 (LOW)	Regulated 24VDC Max. Operating Current (mA) HIGH Setting	Regulated 24VFWR Max. Operating Current (mA) HIGH Setting		Minimum SPL at 10Ft. Per ANSI/UL 464 (HIGH)	Minimum SPL at 10Ft. Per ANSI/UL 464 (LOW)	Regulated 12VDC Max. Operating Current (mA) HIGH Setting	Regulated 12VFWR Max. Operating Current (mA) HIGH Setting
Temp 3 2400Hz	78 dBA	71* dBA	28	48	Temp 3 2400Hz	76 dBA	69* dBA	29	48
Temp 3 Mechanical	76 dBA	70* dBA	25	44	Temp 3 Mechanical	75 dBA	68* dBA	26	45
Temp 3 Chime	70* dBA	66* dBA	15	30	Temp 3 Chime	62* dBA	60* dBA	13	24
Continuous 2400Hz	81 dBA	74* dBA	28	48	Continuous 2400Hz	79 dBA	74* dBA	29	48
Continuous Mechanical	80 dBA	72* dBA	25	44	Continuous Mechanical	78 dBA	72* dBA	26	45
Continuous Chime	70* dBA	66* dBA	15	30	Continuous Chime	63* dBA	61* dBA	13	24
Whoop	82 dBA	69* dBA	56	62	Whoop	78 dBA	71* dBA	55	61

NOTICE:

- THE THREE PULSE TEMPORAL PATTERN IS TO BE USED FOR EVACUATION USE ONLY.
- THE SOUND OUTPUT FOR THE TEMPORAL 3 TONE IS RATED LOWER SINCE THE TIME THE HORN IS OFF IS AVERAGED INTO THE SOUND OUTPUT RATING. WHILE THE HORN IS PRODUCING A TONE IN THE TEMPORAL 3 MODE ITS SOUND PRESSURE IS THE SAME AS THE CONTINUOUS MODE. UNITS HAVE BEEN TESTED TO 0°C, 49°C AND 93% HUMIDITY.

* Operating the horn in this mode at this voltage will result in not meeting the minimum ANSI/UL 464 sound level required for public mode fire protection service. These settings are acceptable only for private mode fire alarm signaling use. Use the high dBA setting for public mode applications (the chime tone is always private mode).

IV. WIRING

Wiring for synchronized strobes and horns.

Using this method you may:

- Use only two wires to synchronize the temporal horn and strobe with the ability to mute the horn (place switches 1 and 2 in the ON position on the GEC24, GEC3-24, GEC3-12, WGEC24, GECA24, GECB24, GEGC24, GEGR24, WGEC24, WGECB24, WGECG24, WGECR24).
- Mute the horn **only** when the temporal horn option has been selected.
- Use the Gentex synchronization protocol to provide synchronization and mute the horn, if available.

Wiring for synchronized parallel (unison) horn/strobe operation.

Using this method you may:

- Use four wires where two wires are used to power and synchronize the strobe and two additional wires are used to power and synchronize the horn (place switches 1 and 2 in the OFF position on the GEC24, GEC3-24, GEC3-12, WGEC24, GECA24, GECB24, GEGC24, GEGR24, WGEC24, WGECB24, WGECG24, WGECR24).
- Choose either continuous horn and allow the FACP to control the horn or choose temporal horn and synchronize the horns with the Gentex synchronization protocol.
- Use the Gentex synchronization protocol to provide synchronization and mute the horn, if available.

NOTICE:

- FOR THIS OPTION, SWITCHES 1 AND 2 ON THE GEC24, GEC3-24, GEC3-12, WGEC24, GECA24, GECB24, GEGC24, GEGR24, WGEC24, WGECB24, WGECG24, WGECR24 MUST BE IN THE OFF POSITION TO ISOLATE POWER TO THE AUDIBLE AND VISIBLE PORTION OF THE CIRCUIT.
- ALL STROBES ARE DESIGNED TO FLASH AS SPECIFIED WITH CONTINUOUS APPLIED VOLTAGE. THIS APPLIANCE IS NOT RECOMMENDED FOR USE ON CODED OR PULSING SIGNALING CIRCUITS. HOWEVER, USE OF THE AVSM CONTROL MODULE IS PERMITTED TO SYNCHRONIZE THE STROBE AND/OR MUTE THE HORN.
- REFERENCE AVSM CONTROL MODULE MANUAL (550-0284, DATED 2-1-03) FOR SYNCHRONIZATION MODULE WIRING DIAGRAMS. AVSM MANUAL CAN BE OBTAINED AT [HTTP://WWW.GENTEX.COM](http://WWW.GENTEX.COM) OR CALL GENTEX CORPORATION AT 1-800-436-8391.

Conventional Method:

You may connect both the strobe and the horn directly from a source of rated power without the use of a control module. However, the horns and strobe lights will NOT be synchronized. Place switches 1 and 2 in the ON position on the GEC24, GEC3-24, GEC3-12, WGEC24, GECA24, GECB24, GEGC24, GEGR24, WGEC24, WGECB24, WGECG24, WGECR24 to power both the audible and visible from a single pair of power wires. If you wish to power the horn and strobe from independent sources of power, place switches 1 and 2 in the OFF position on the GEC24, GEC3-24, GEC3-12, WGEC24, GECA24, GECB24, GEGC24, GEGR24, WGEC24, WGECB24, WGECG24, WGECR24 and connect power to the appropriate terminals.

MAX. WIRE DISTANCE (IN FEET)	=	$\frac{(\text{PANEL VOLTAGE}-\text{APPLIANCE MIN. VOLT}) \times \text{WIRE CONDUCTIVITY}}{\text{TOTAL CURRENT DRAW}}$
	WIRE	CONDUCTIVITY
	18AWG	60
	16AWG	95
	14AWG	153
	12AWG	244

Includes wire to and from appliance. **CAUTION:** Applies only to regulated supplies. Assumes all appliances are at the end of wire run (worst case).

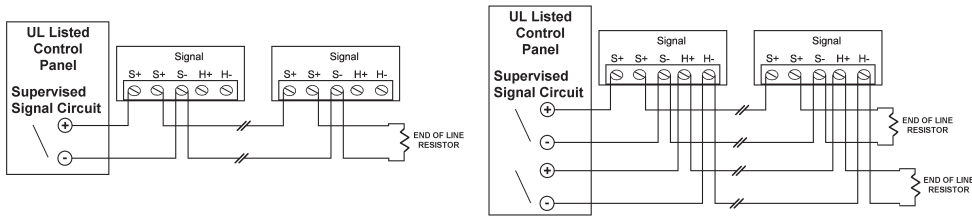

CAUTION: When using only a single power source to energize the strobe and horn (switches 1 and 2 in the ON position), the in/out wiring must be under the S+ and S- terminals only. Failure to do so may result in damage to your signal. For the horn only (GEH24 and GEH12) and strobe only (GES24, GES3-24, GES3-12, WGES24, GESA24, GESB24, GESG24, GESR24, WGESA24, WGESB24, WGESG24, WGESR24), only the top three terminals are to be used.

TONE	SWITCH POSITION		
	3	4	5
Mechanical Temporal 3	ON	ON	ON
Mechanical - Continuous	OFF	ON	ON
2400Hz - Temporal 3	ON	OFF	ON
2400Hz - Continuous	OFF	OFF	ON
Chime - Temporal 3	ON	ON	OFF
Chime - Continuous	OFF	ON	OFF
Whoop	ON	OFF	OFF
Whoop	OFF	OFF	OFF

NOTICE:

- SWITCH POSITIONS 1 AND 2 IN THE OFF POSITION TO SELECT ISOLATED HORN AND STROBE POWER INPUTS
- SWITCH POSITION 6 ON = HIGH DBA
- SWITCH POSITION 6 OFF = LOW DBA

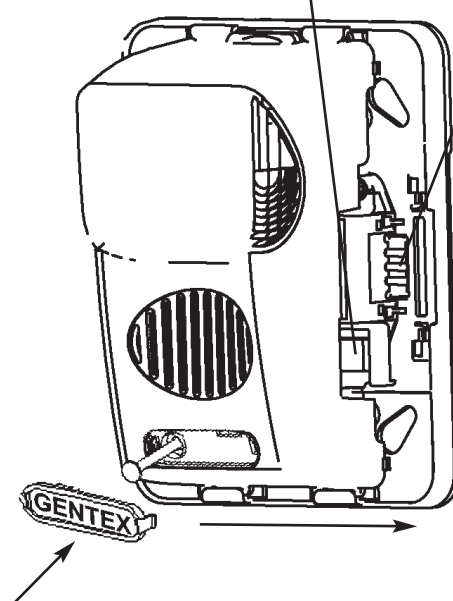
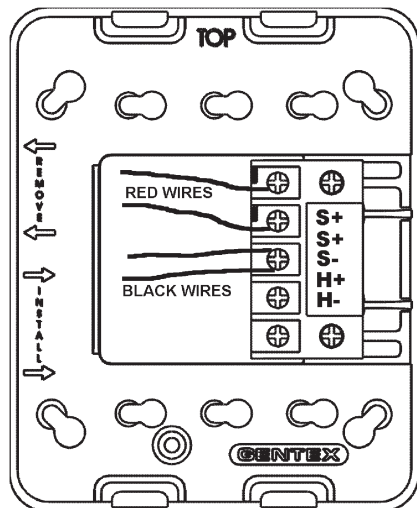
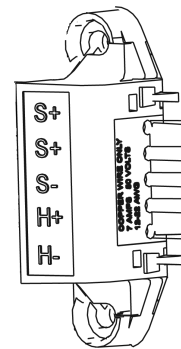
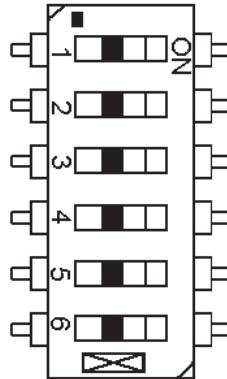

Gentex Super-Slide® Mounting Bracket:

Allows the installer to pre-wire the system, test for system supervision, remove the signal head until occupancy, switch out Gentex signals without changing mounting brackets and has locking edge connector for snap-in-place installation.

Gentex Checkmate® Instant Voltage Verification:

It is often necessary to confirm the voltage drop along a line of devices. The access holes are provided in the back of the terminal block to allow the voltage to be measured directly without removing the device. Typically this would be done at the end of the line to confirm design criteria. Most measurements will be taken using the S+ and S- locations although access is provided to other locations. **NOTICE:** CARE SHOULD BE TAKEN TO NOT SHORT THE TEST PROBES.

CAUTION: A jumper card is provided to test for correct wiring in the supervisory mode only. DO NOT pass alarm current through the jumper.

Candela selection slider switch. Depress center and slide switch to desired brightness level.

Break off pin and insert into hole at the bottom of the selector to lock candela setting. Signal must be removed from bracket and pin pushed forward from backside out of hole to change candela.

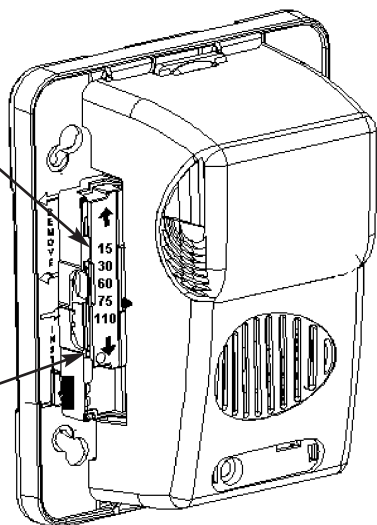

FOR MODELS: GEC3-24, GES3-24, GEC3-12, GES3-12, GECA24, GESA24, GECB24, GESB24, GECG24, GESG24, GEGR24, GESR24 ONLY

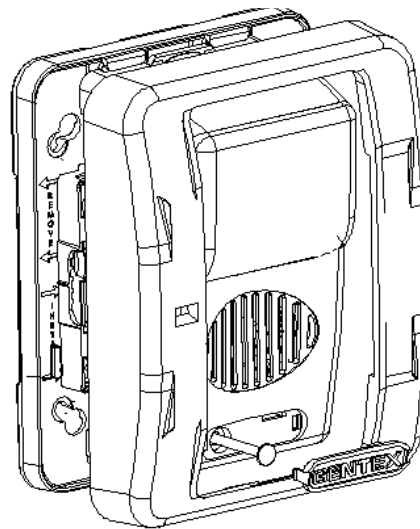

To remove bezel, grip both sides of bezel and pull in a downward and outward motion.

FOR MODELS: GEC24, GES24, GEH24, GEH12, GEC3-24, GES3-24, GEC3-12, GES3-12, GECA24, GESA24, GECB24, GESB24, GECG24, GESG24, GEGR24, GESR24 ONLY

▲ WARNING

THIS APPLIANCE WILL NOT OPERATE WITHOUT ELECTRICAL POWER. AS FIRES FREQUENTLY CAUSE POWER INTERRUPTIONS, GENTEX SUGGESTS YOU DISCUSS FURTHER SAFEGUARDS WITH YOUR LOCAL FIRE PROTECTION SPECIALIST.

V. CHECKOUT AND TROUBLESHOOTING

1. Supply power to the system control panel. The auxiliary signaling appliances in the system should not be activated.
2. If the signal is activated:
 - Check all smoke and fire detectors in the system to make sure they have not been activated.
 - Check all wiring connections to make sure the signal detection circuits are not reversed or shorted together. Check wire color codes and traces.
 - Verify that the jumpers and switches are properly set on both the control module and signal appliance. If the jumper on the AVSM is removed, the horns will not produce any sound unless there is an input to the H+ and H- terminals on the control module.
3. To test the signal appliances, trip the auxiliary panel or activate the alarm circuit at the main control panel or activate one of the fire detection units in the system. All auxiliary signals should be activated.
4. An operational test on this product should be conducted in accordance with National Standards or at a minimum annually and more often if dictated by local and state codes or authorities having jurisdiction.

NOTICE: THESE TESTING PROCEDURES AND TROUBLESHOOTING INSTRUCTIONS ARE GENERALIZED. PLEASE REFER TO THE SYSTEM CONTROL PANEL OPERATING INSTRUCTIONS FOR PROPER OPERATION OF THE PANEL AND FIRE DETECTION SYSTEM.

SIGNALING APPLIANCE LIMITATION:

Your horn and horn/strobe meet or exceed the current audibility requirements of ANSI/UL 464. However, if the appliance is located outside a bedroom it may not wake up a sound sleeper, especially if the room door is closed or only partially open.

VI. TO RETURN AN APPLIANCE

Should you experience problems with your appliance, proceed as follows:

1. Turn off electrical power to the auxiliary alarm circuit.
2. Remove the bezel, nameplate, then mounting screw and slide signal off from bracket
3. Replace unit that was removed to restore wiring supervision and to eliminate system trouble alert.
4. Carefully pack the defective unit (the manufacturer cannot be responsible for consequential damage due to shipping or mis-handling). Include a return address and complete details as to the nature of the difficulties being experienced and date of installation.
5. Return to: Gentex Corporation, 10985 Chicago Dr., Zeeland MI 49464. Prior to returning, call Gentex at 1-800-436-8391 or e-mail FP_RMA@gentex.com to obtain a RMA Number from our Customer Service Department.

LIMITED WARRANTY

For a period of 36 months from the date of purchase or a maximum of 42 months from the date of manufacture, Gentex warrants to you the original purchaser that your appliance will be free from defects in workmanship, materials and construction under normal use and service. If a defect in workmanship, materials and construction should cause your appliance to become inoperative within the warranty period, Gentex will repair your appliance or furnish you with a new or rebuilt appliance without charge to you except for postage required to return the appliance to us. Gentex will not reimburse you for repairs or replacement parts provided by other parties. Your repaired or replacement appliance will be returned to you free of charge and it will be covered under the warranty for the balance of the warranty period.

The warranty is void if our inspection of your appliance shows that the damage or failure was caused by abuse, misuse, abnormal usage, faulty installation, improper maintenance or repairs other than those performed by us.

ANY WARRANTIES IMPLIED UNDER ANY STATE LAW INCLUDING IMPLIED WARRANTIES OF MERCHANTABILITY OR FITNESS FOR A PARTICULAR PURPOSE APPLY ONLY FOR THE WARRANTY PERIOD SPECIFIED ABOVE. PLEASE NOTE THAT SOME STATES DO NOT ALLOW LIMITATION ON HOW LONG AN IMPLIED WARRANTY LASTS. SO THE ABOVE LIMITATION MAY NOT APPLY TO YOU. GENTEX WILL NOT BE LIABLE FOR ANY LOSS, DAMAGE, INCIDENTAL OR CONSEQUENTIAL DAMAGES OF ANY KIND ARISING IN CONNECTION WITH THE SALE, USE OR REPAIR OF THIS APPLIANCE. THE MAXIMUM LIABILITY OF GENTEX SHALL NOT IN ANY CASE EXCEED THE PURCHASE PRICE PAID BY YOU FOR THE APPLIANCE. PLEASE NOTE THAT SOME STATES DO NOT ALLOW THE EXCLUSION OR LIMITATION OF INCIDENTAL OR CONSEQUENTIAL DAMAGES, SO THE ABOVE LIMITATION OR EXCLUSION MAY NOT APPLY TO YOU.

If a defect in workmanship, materials or construction should cause your appliance to become inoperative within the warranty period, you must return the appliance to Gentex postage prepaid. You must prove to the satisfaction of Gentex the date of purchase of your appliance. Warranty service may only be performed by Gentex personnel at Gentex's facilities in Zeeland, Michigan. You must also pack the appliance to minimize the risk of it being damaged in transit. You must also enclose a return address. Appliances returned for warranty service should be sent to: Gentex Corporation, 10985 Chicago Dr., Zeeland MI 49464. If we receive an appliance in a damaged condition as the result of shipping, we will notify you and you must seek a claim with the shipper.

THIS WARRANTY GIVES YOU SPECIFIC LEGAL RIGHTS AND YOU MAY ALSO HAVE OTHER RIGHTS WHICH VARY FROM STATE TO STATE.

Important Notice:

These materials have been prepared by Gentex Corporation ("Gentex") for informational purposes only, are necessarily summary, and are not purposed to serve as legal advice and should not be used as such. Gentex makes no representations and warranties, express or implied, that these materials are complete and accurate, up-to-date, or in compliance with all relevant local, state and federal laws, regulations and rules. The materials do not address all legal considerations as there is inevitable uncertainty regarding interpretation of laws, regulations and rules and the application of such laws, regulations and rules to particular fact patterns. Each person's activities can differently affect the obligations that exist under applicable laws, regulations or rules. Therefore, these materials should be used only for informational purposes and should not be used as a substitute for seeking professional legal advice. Gentex will not be responsible for any action or failure to act in reliance upon the information contained in this material.